

Mars Explorer Mecanum Wheel Robotic Kit (Arduino Mega2560)

360°

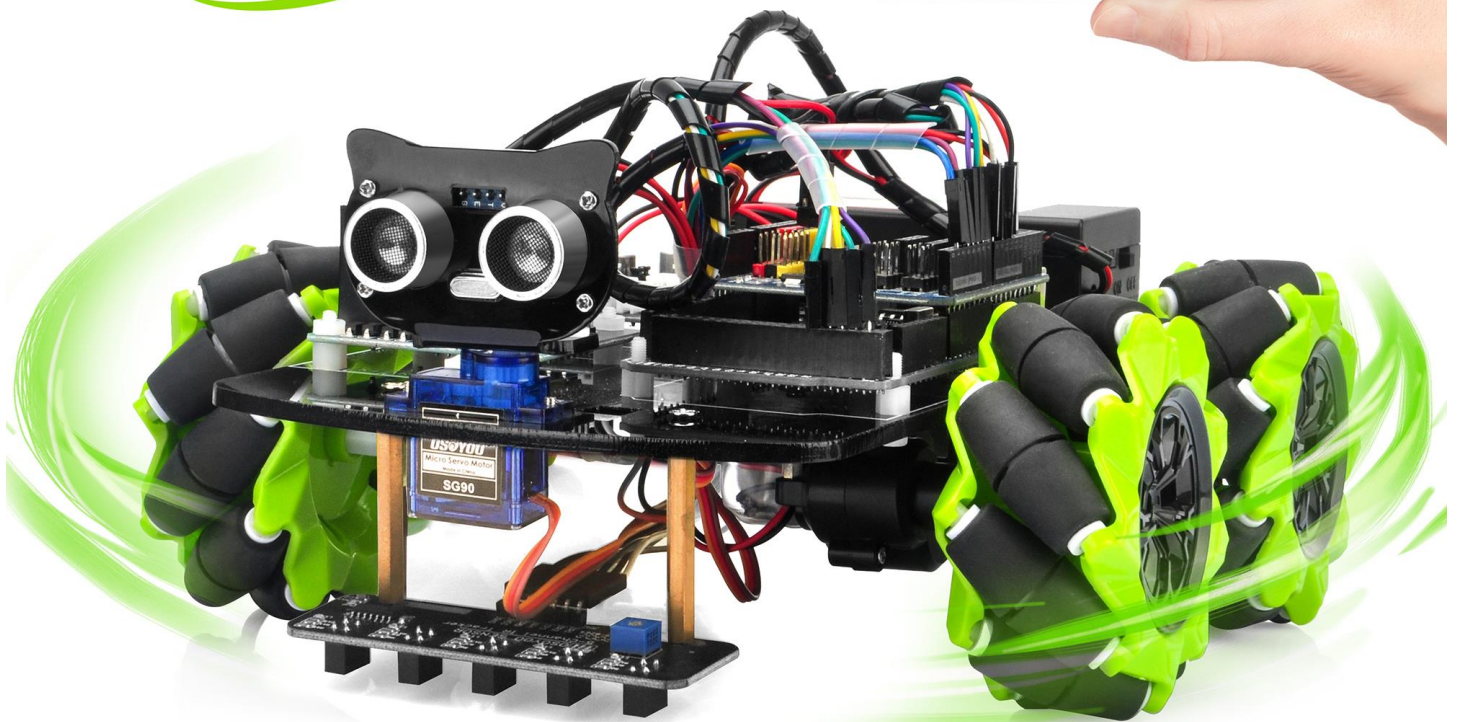

Easy Assembly



Omni-wheel



Wifi Control



Obstacle
Avoidance



Line Tracking

More information: <http://osoyoo.com/?p=30176>

INTRODUCTION

Mecanum wheels, also known as omni wheels or Ilon wheels, consist of a hub with rollers oriented 45 ° to the axis of rotation. The mecanum wheels are wheel hubs fitted with integrated rollers that move passively and independently.

Depending on which wheels rotate in which direction, the platform will move forward, backward, sideways, diagonally, or spin in place. This range of maneuverability enables the Omni Platform to efficiently navigate any space, particularly around tight corners, narrow lanes, and complex pathways.

This Arduino Omini Direction Robot Car learning kit is developed our Japan and Canada engineer team. It has all features a traditional Arduino Robot car should have, including remote control by Bluetooth, IoT through Wifi, Line tracking and Obstacle Avoidance auto driving. With the help of powerful Mecanum wheels, the car can make much more complicated movement such as sideway shifting and diagonally movement controlled by Cell phone APP.

The kit comes with OSOYOO MEGA2560 board (fully compatible with Arduino MEGA2560) and OSOYOO ESP8266 Wifi Shield. Besides, we have designed five step by step lessons which help students to learn Arduino robot programming from scratch. If you are an experience DIY player or Arduino programmer, you can also get a lot of knowledge from this kit's open source code and hardware to make interesting DIY project of your own.

AUTHORIZED ONLINE RETAILERS

Buy from US	Buy from UK	Buy from DE	Buy from IT	Buy from FR	Buy from ES	Buy from JP
						

This full package kit didn't come with 18650 batteries (3.7V), you need to buy a pair of [18650 batteries and charger](#) separately.

CONTEXT

Lesson 1: Assembling the Car	4
Lesson 2: Obstacle Avoidance Robot Car	15
Lesson 3: Tracking Line Robot Car.....	20
Lesson 4: Bluetooth Imitation Robot Car.....	24
Lesson 5: Wifi IoT Control Robot Car	29

Lesson1: Assembling the Car

OBJECTIVE

Mecanum Omni direction wheel is a very interesting wheel which allows robot car make omni-directional movement(parallel shift to left and right).

In this project, we will show how to use Arduino to control an Osoyoo Brand Mecanum wheel robot car to make some basic movement including go forward, backward, left turn, right turn, parallel left shift, parallel right shift etc.

This lesson also shows you how to install the chassis of this car and connect Arduino control signal wires to two model-X (L298N) driver board. This installation will be the start point of our other lessons.

PARTS & DEVICES

OSOY00 Mecanum wheels robotic car chassis x1(2xleft-wheels/2xright-wheels and Motor x 4)

OSOY00 Mega2560 board fully compatible with Arduino UNO/Mega2560 x 1

OSOY00 Wifi shield x 1

OSOY00 Model X motor driver x 2

OSOY00 Battery box x 1

Model X to Model X connection white cable (2 pin XH.25 female to female) x 1

[18650 batteries\(3.7V\) x 2](#) (the kit don' t include the batteries and charger, click it to buy it separately)

HARDWARE INSTALLATION

Size dimensions:

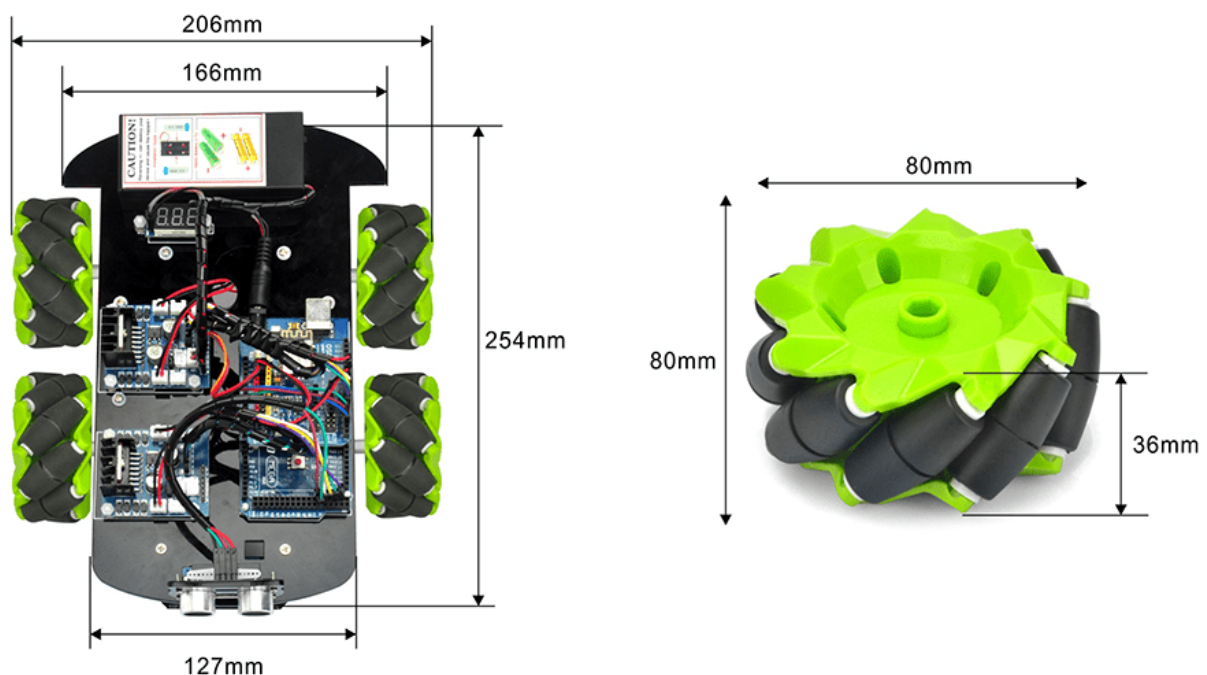

Step1: Install 16pcs M3 plastic nuts and plastic pillars as per the chassis screw location map (view from top).

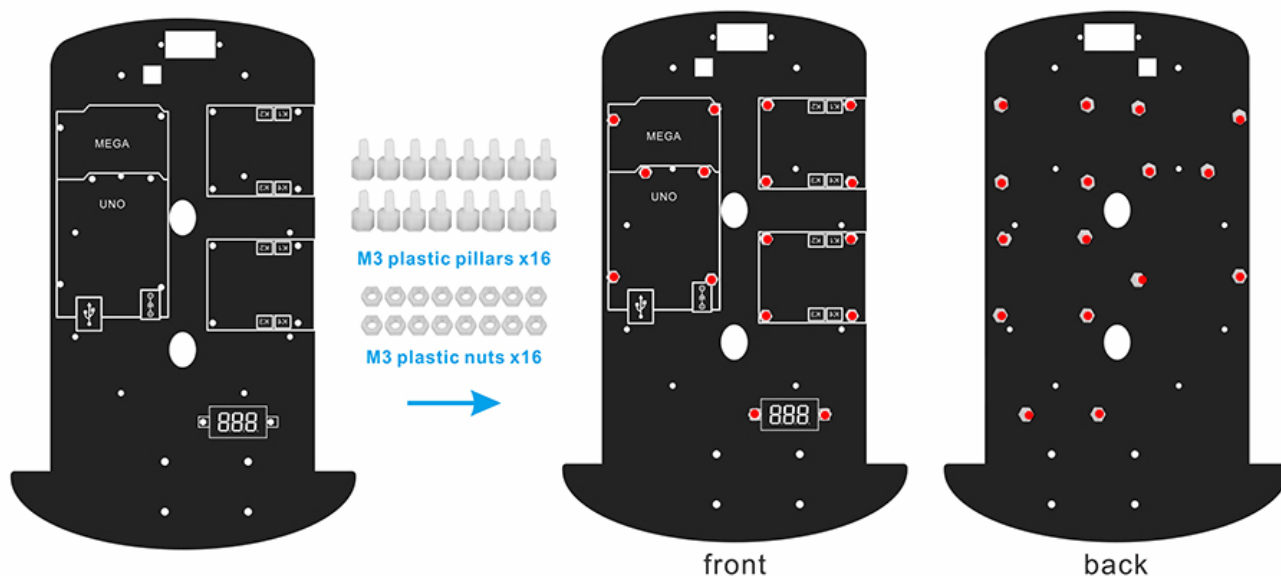

Step2: Install 4 copper standoff on the positions of the blue lines as per the picture. Motor fasten screws location map (view from bottom of the chassis).

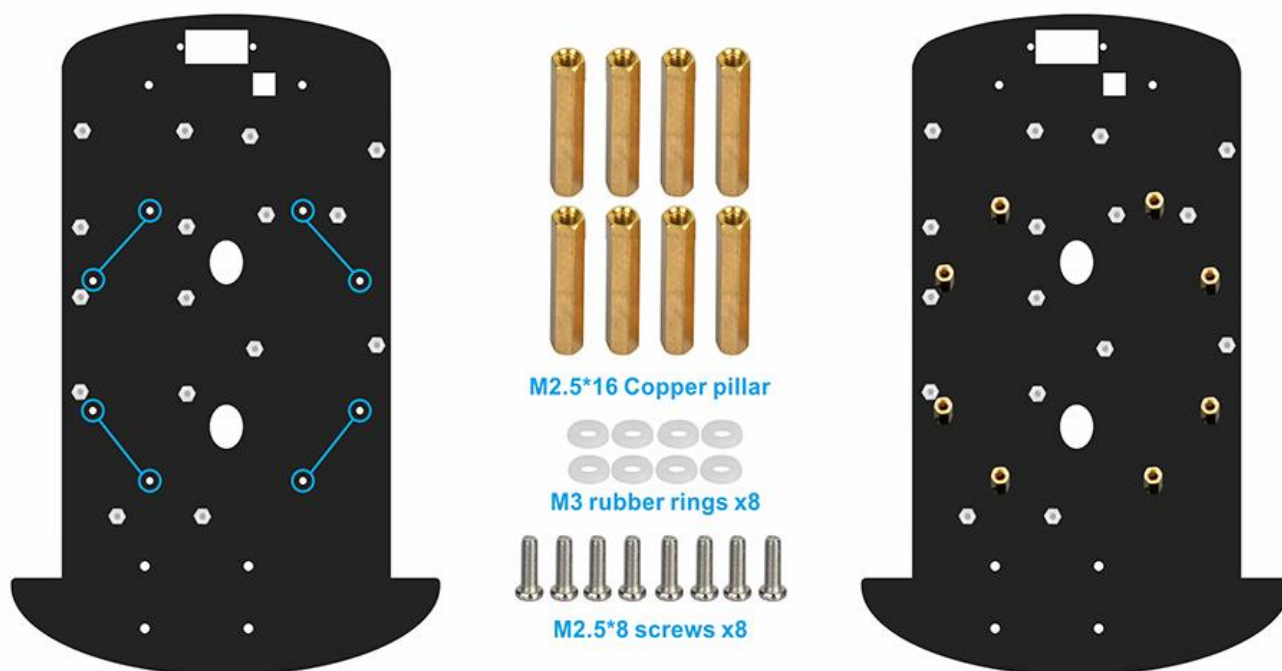

Step3: Fasten the 4 motors onto the 4 standoffs with M2.5x8 screws. Make sure the motor directions must be correct.

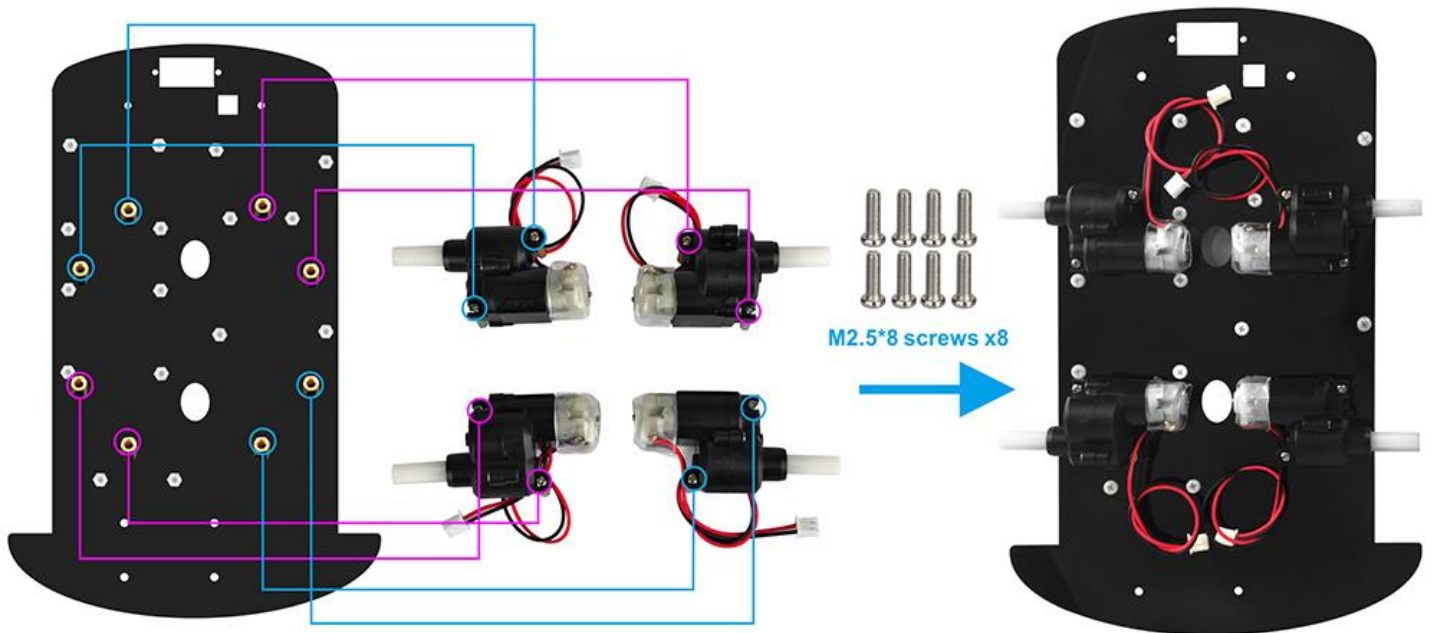

Step4: Install the 4 wheels with 4pcs M2.6x14 screws as per the following pictures (view from bottom of the chassis).

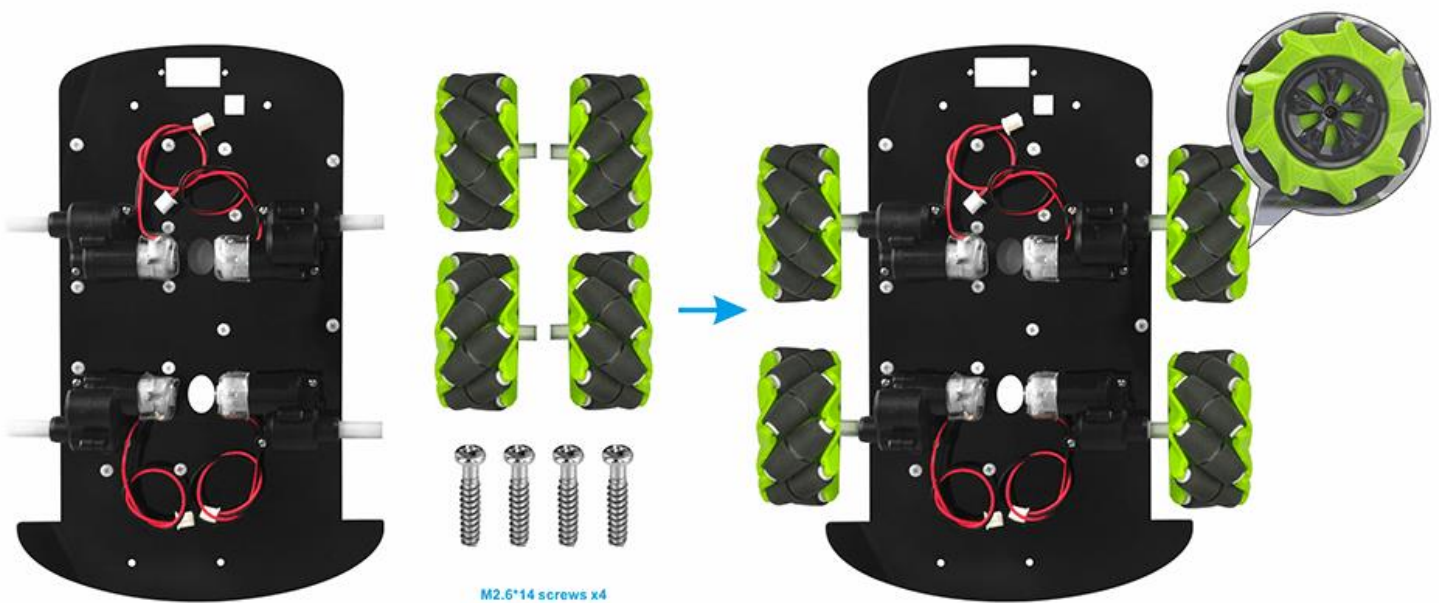

The Mecanum wheel has some sub-wheels on the main wheel. The four Mecanum wheels have two types by the sub-wheel directions. Check the type A wheel and type Wheel by following picture 8 left side. You must 100% sure that correct type of wheel is installed into correct position as per picture 8 right side, the rolling direction of each wheel will determine the whole car moving directions showed in the picture.

A wheel

B wheel

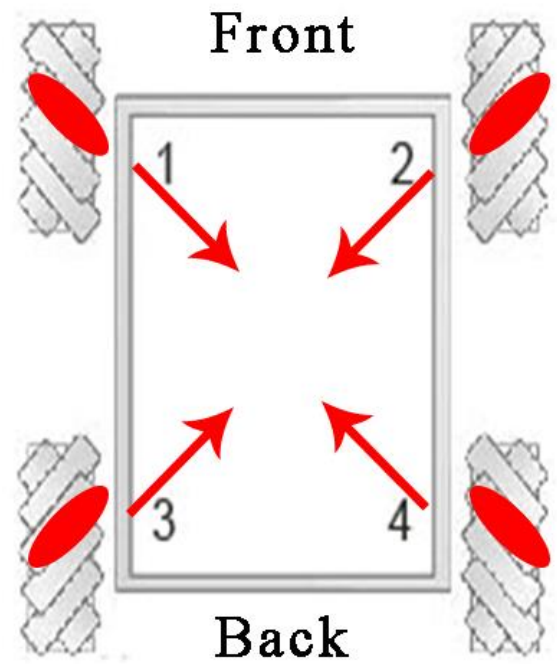
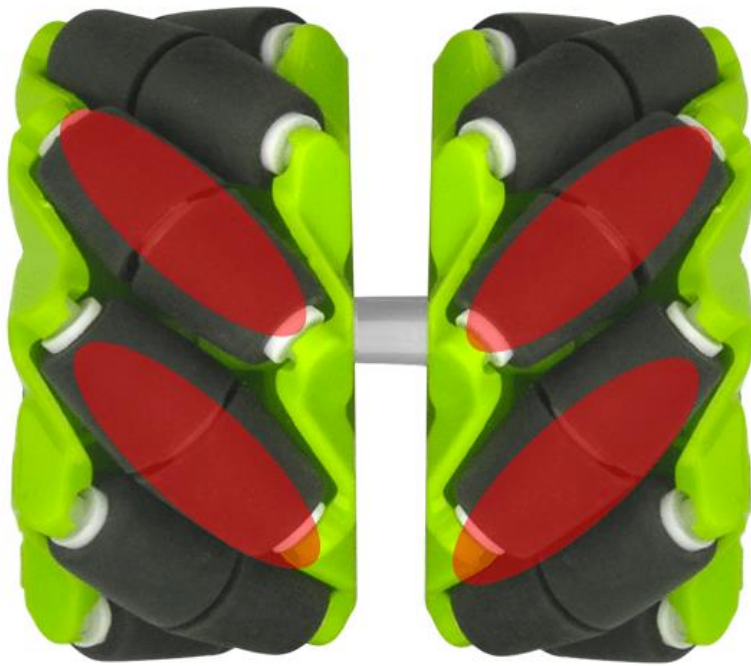

Different rotation combination of 4 wheels will result in different car movement directions. Following pictures shows how they works.

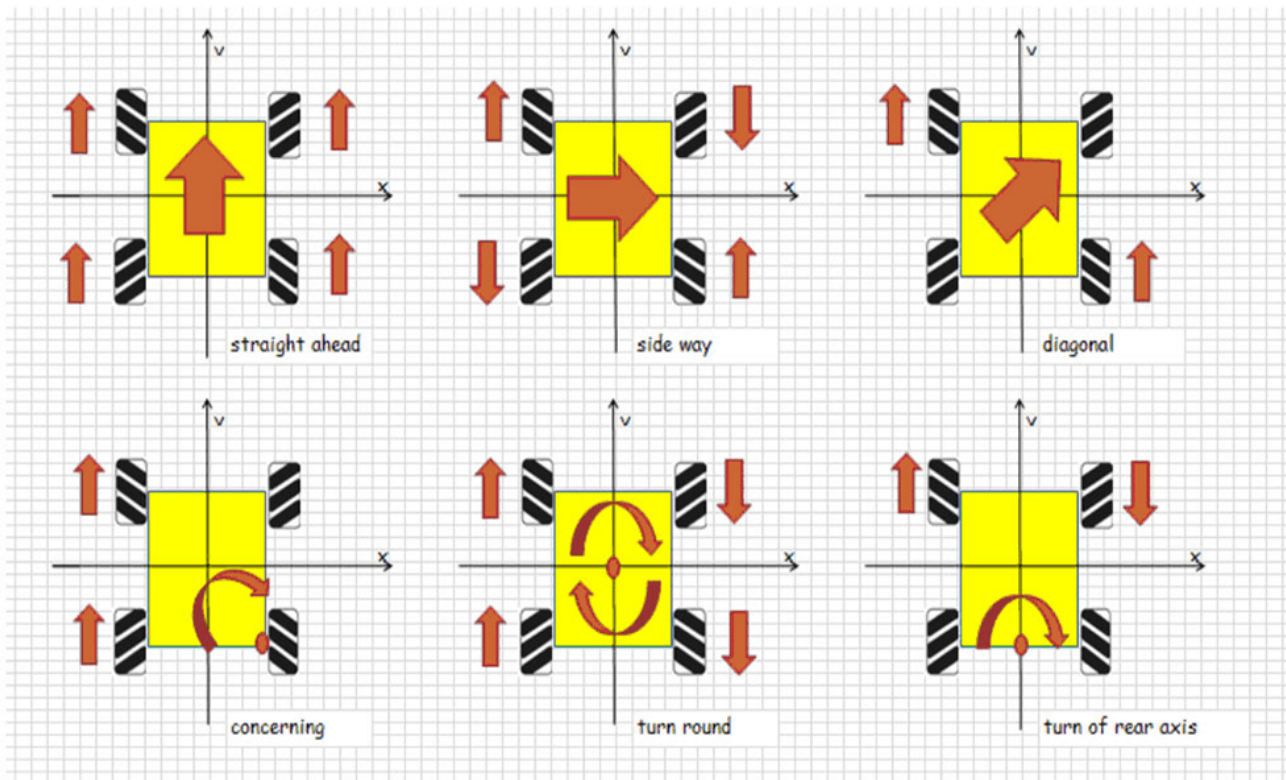

Step5: Install Mega2560, Model X boards(L298N), Wifi shield and voltage meter onto the chassis with M3 nuts.

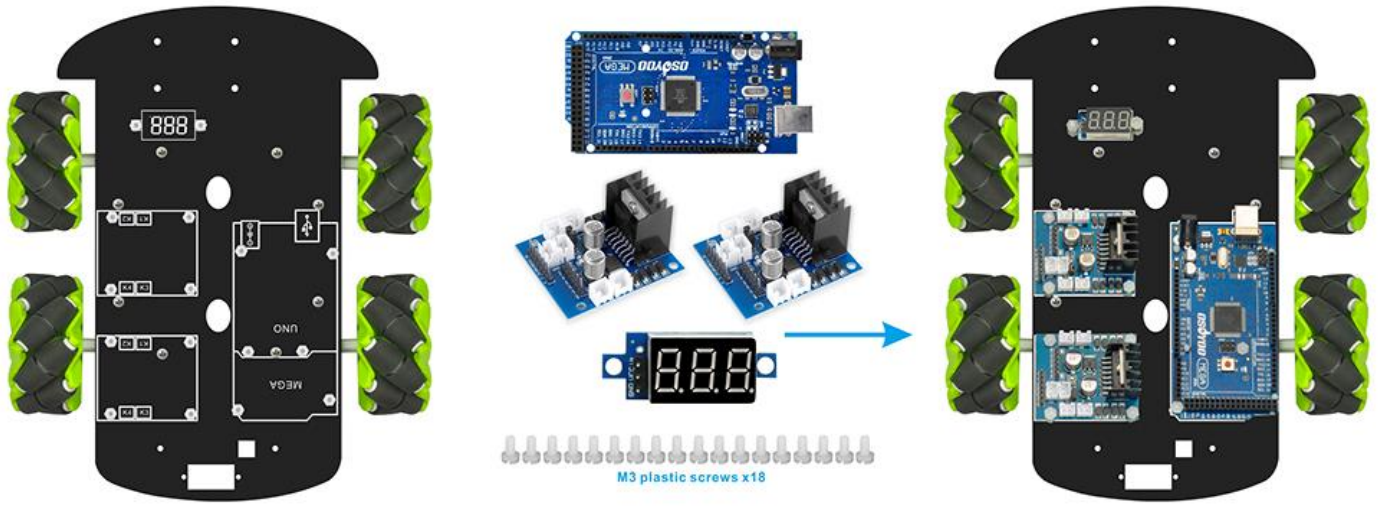

Step6: Install battery box with 4pcs M3x10 screws.



Step7: Insert OSOY00 Uart WIFI shield onto your mega2560 board.

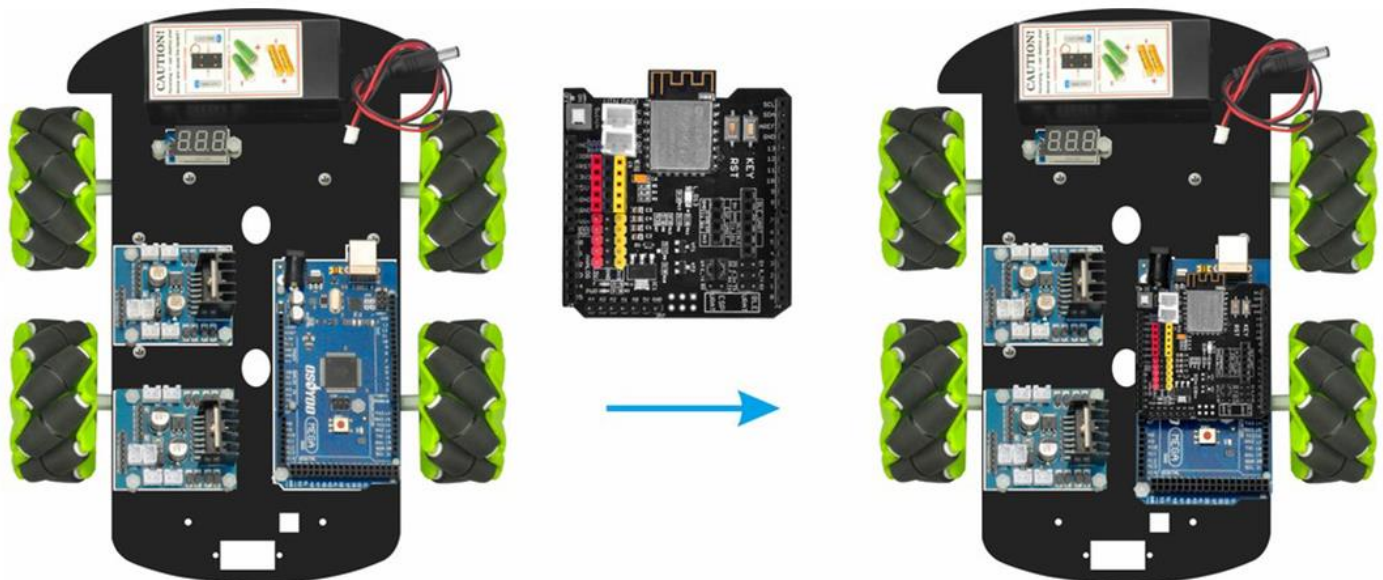

CIRCUIT CONNECTION

Caution:

When insert/remove the 6-pin parallel cable plug into Model X 6-pin male socket, please hold the black plastic pin-holder to do operation. Never drag the wires to pull the plug out of the socket, otherwise it will damage the wires.

Step1: Connect front model X board to front motors as per the picture.

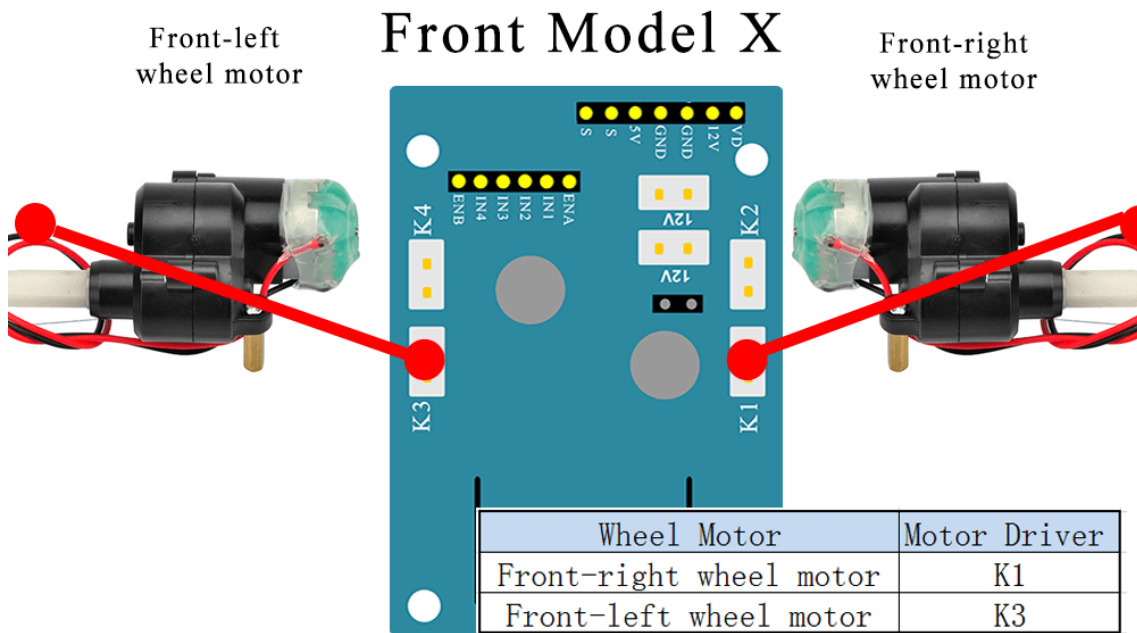

Step2: Connect rear model X board to rear motors as per the picture.

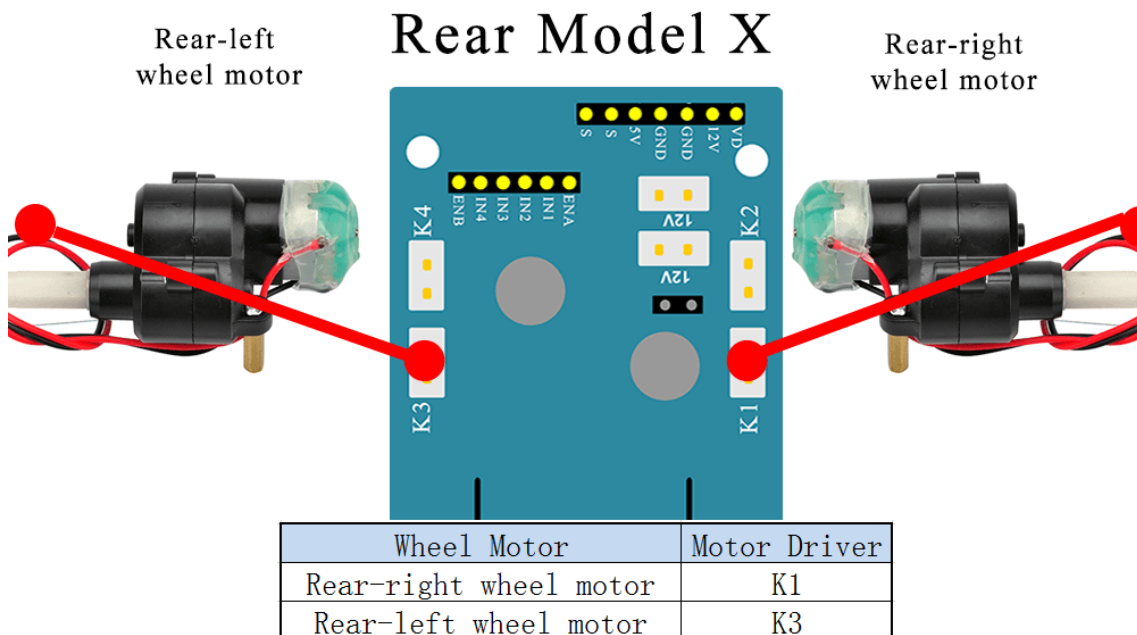

Step3: Connect front model X control pins to MEGA2560 with 6pin male to female jumper wire.

Note: wire (purple wire) is connected to D22 which is located on the SECOND female hole from right in following picture. Many people treat the first hole as D22. THIS IS WRONG.

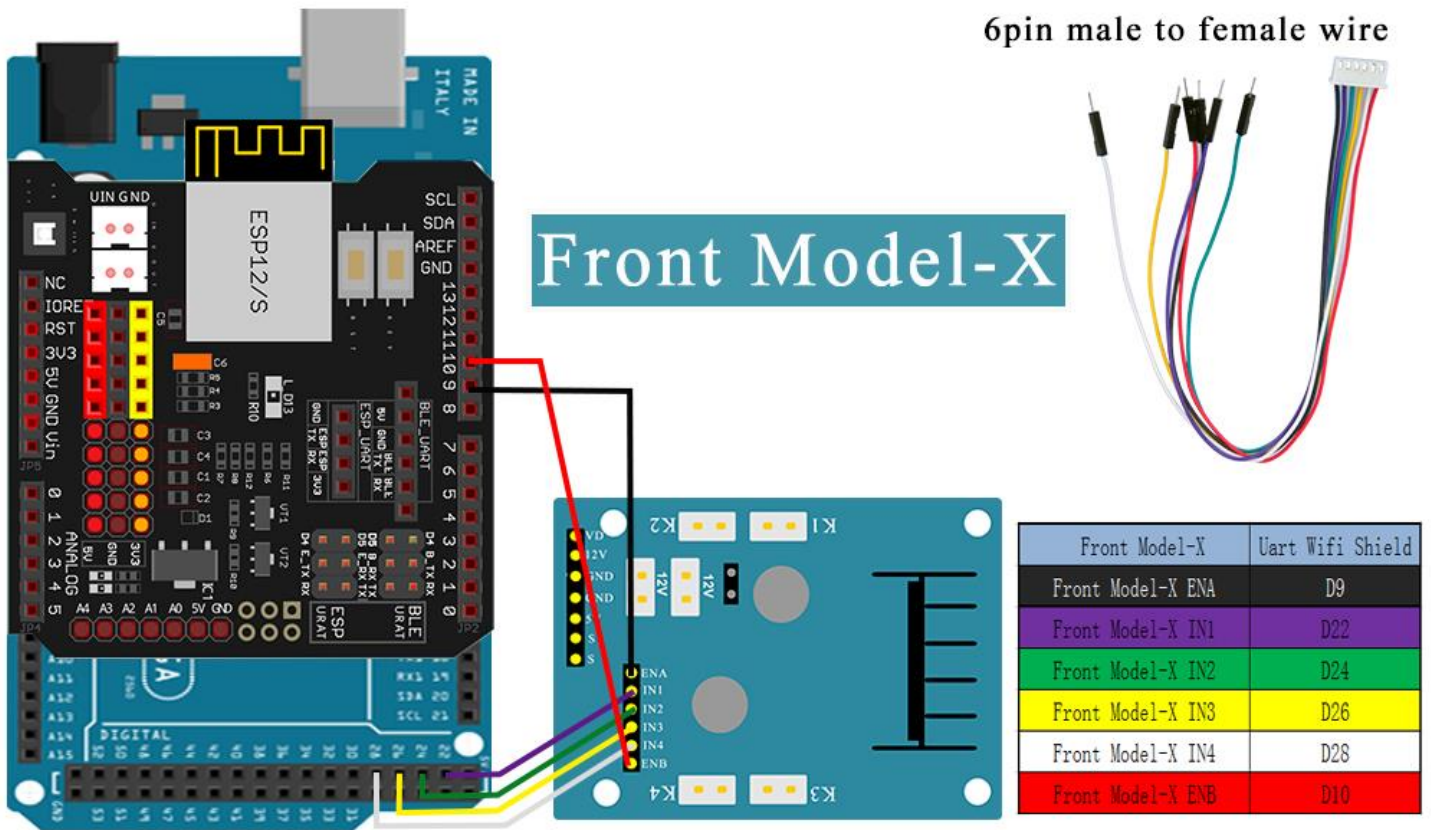

Front Model X board IN1, IN2, IN3, IN4 pin connect to D22, D24, D26, D28.

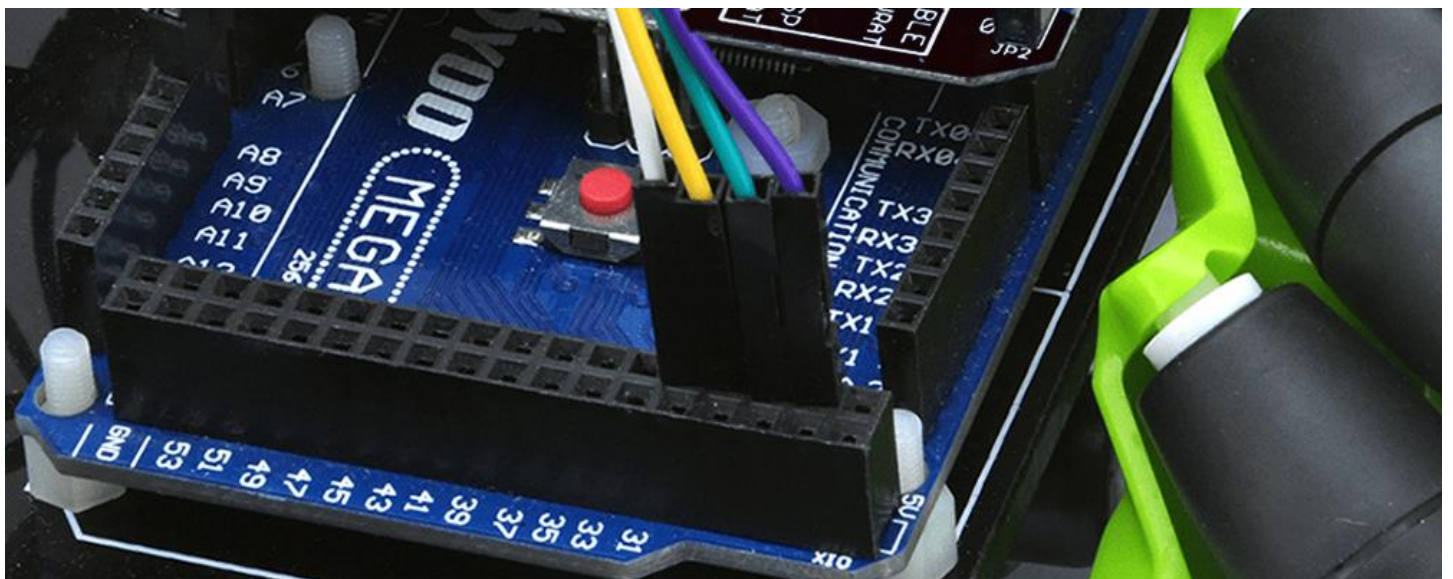

Step4: Connect Rear model X control pins to Mega2560 with 6pin male to female jumper wire.

Rear Model X board IN1, IN2, IN3, IN4 pin connect to D5, D6, D7, D8.

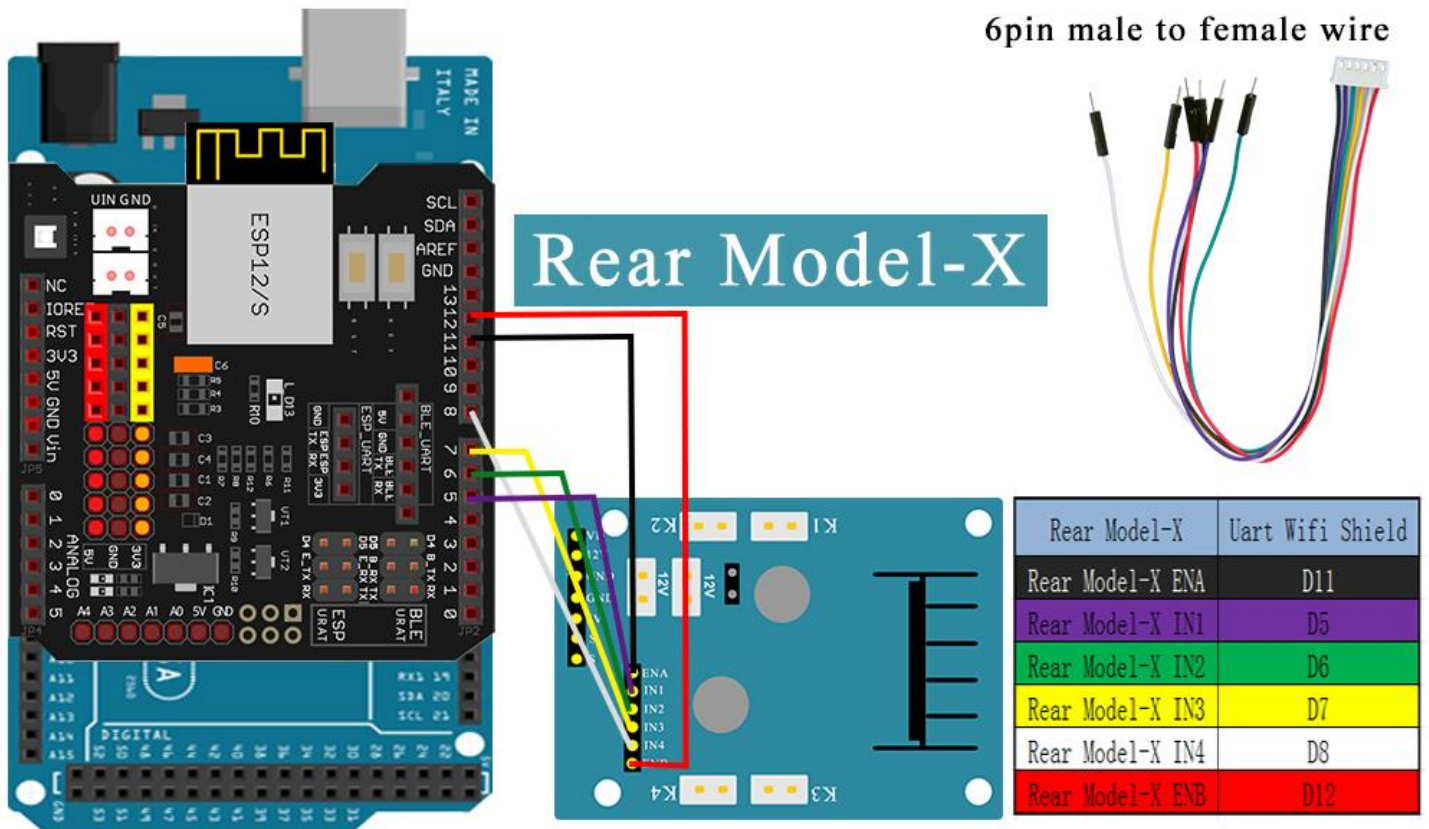

Step5: Connect Voltage meter to model X with 3pin female to female jumper wire.

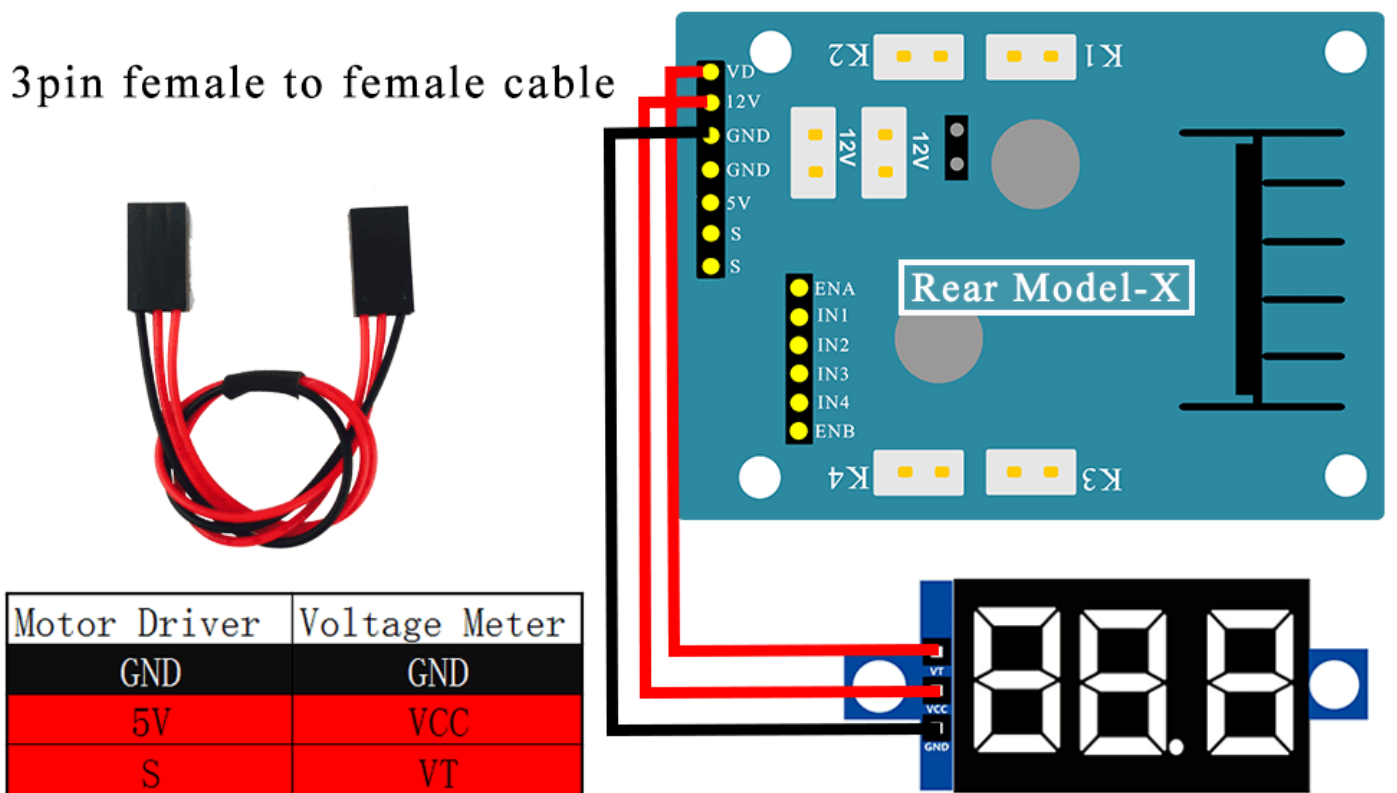

Step6: Connect OSOY00 two model X board 12V-GND socket with 2pin XH2.54 cable 20cm as per following graph.

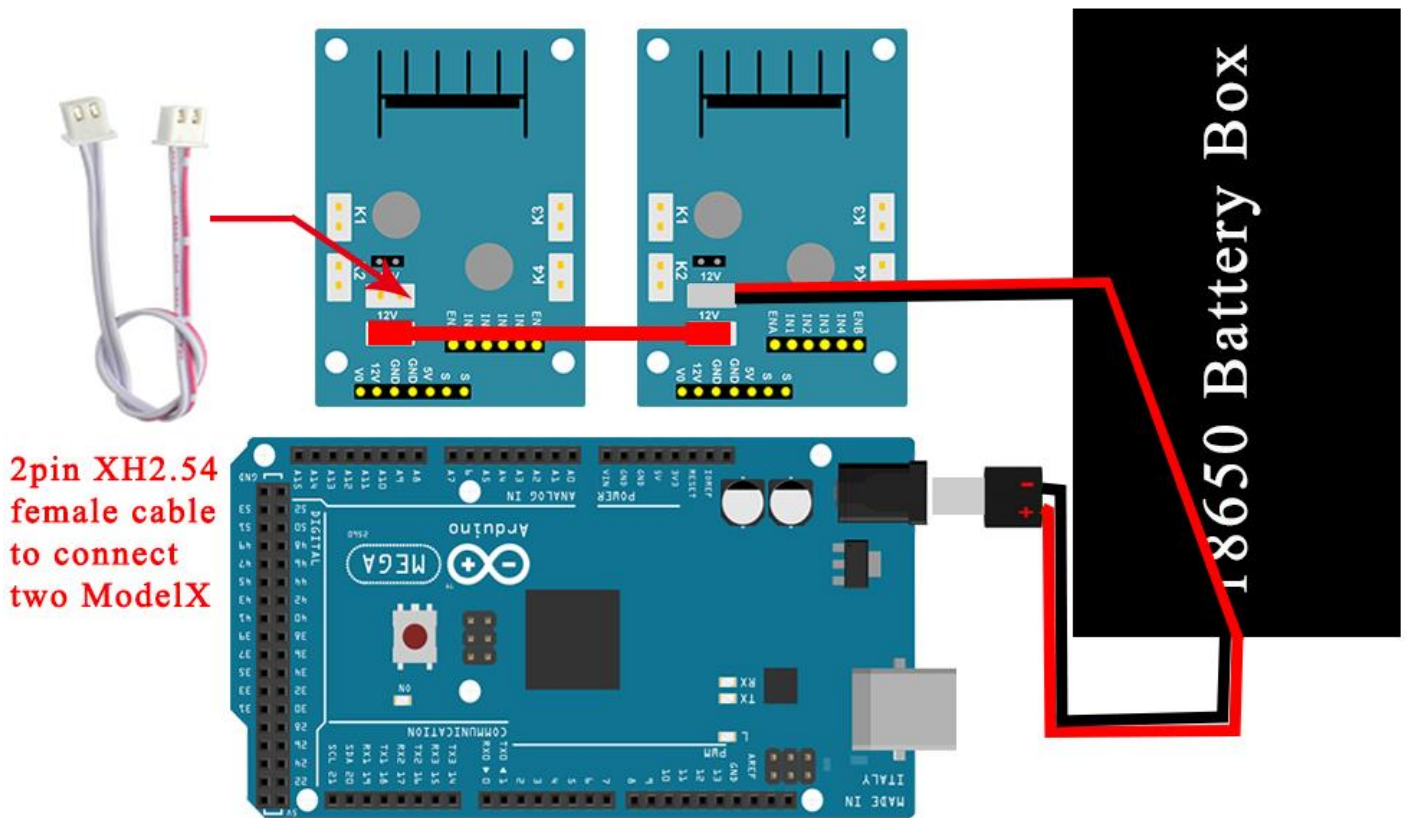

SOFTWARE INSTALLATION

<p>Open-source Arduino Software(IDE)</p>		<p>Download Arduino IDE here: https://www.arduino.cc/en/Main/Software?setlang=en</p>
<p>7 zip is a free zip utility that un-zips zip files</p>		<p>Download 7zip here for free https://www.7-zip.org/</p>

Step 1: Install latest Arduino IDE (If you have Arduino IDE version after 1.1.16, please skip this step). Download Arduino IDE from <https://www.arduino.cc/en/Main/Software?setlang=en> , then install the software.

Step 2: Download [https://osoyoo.com/driver/mecanum acrylic chassis/mecanum-2560-lesson1.zip](https://osoyoo.com/driver/mecanum%20acrylic%20chassis/mecanum-2560-lesson1.zip), unzip the download zip file lesson1.zip, you will see a folder called lesson1 .

Step 3: Connect mega2560 board to PC with USB cable, Open Arduino IDE -> click file -> click Open -> choose code “lesson1.ino” in lesson1 folder, load the code into arduino.

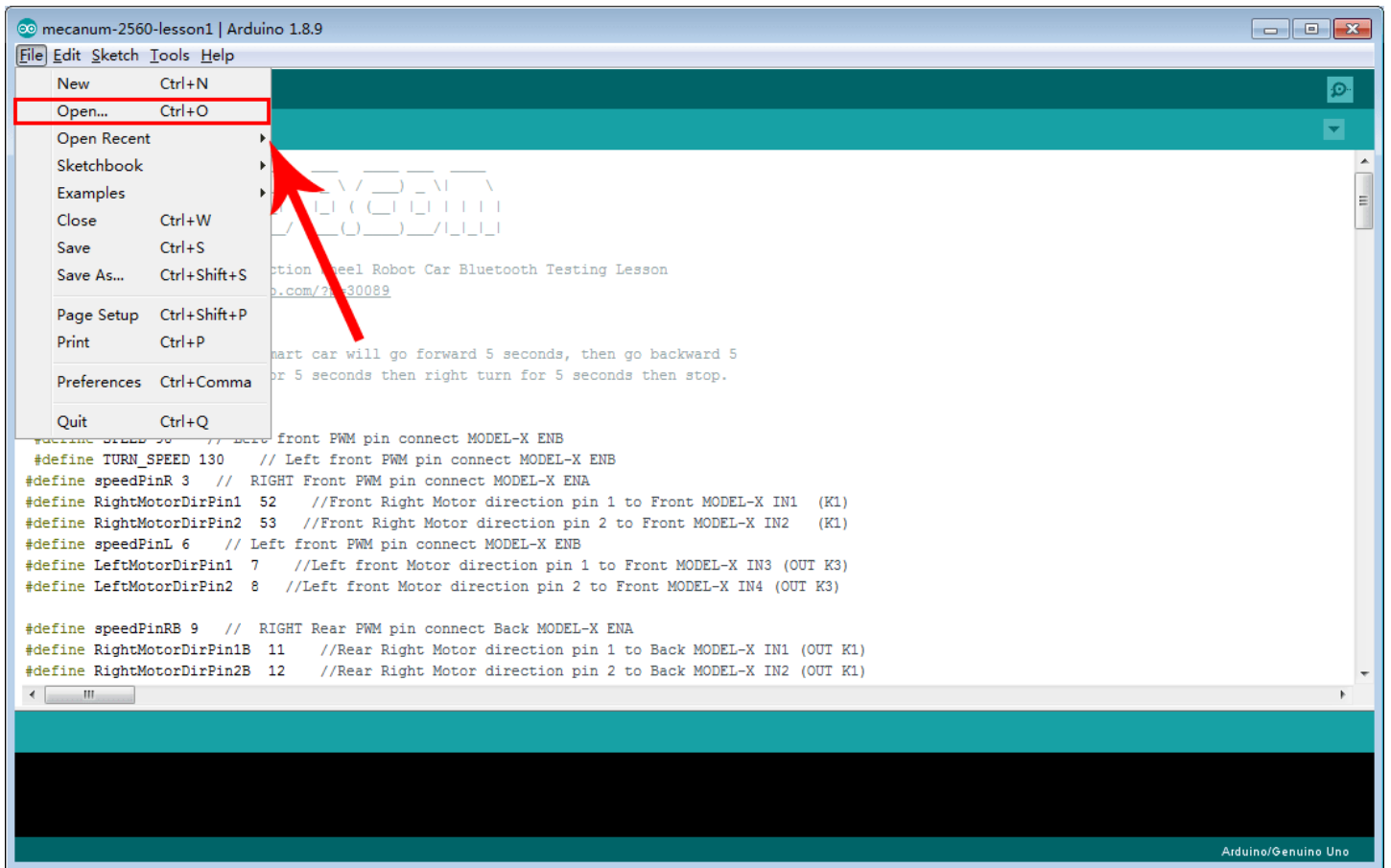

Step 4: Choose corresponding board/port for your project, upload the sketch to the board.

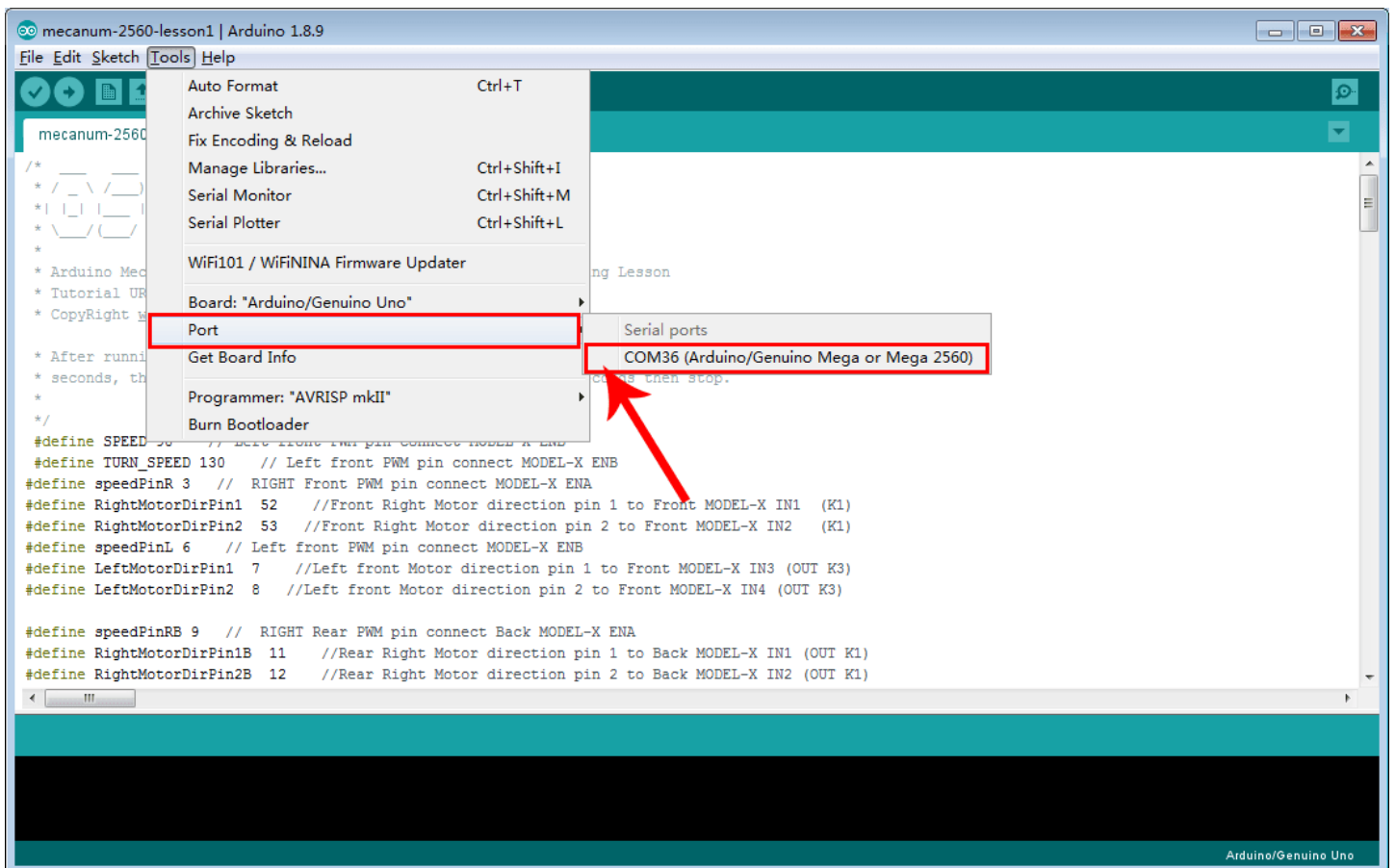

HOW TO PLAY

After running Lesson 1 code, the car will move

Forward/Backward

Left/Right Turn

Right Parallel Shift/Left Parallel Shift

Down Left Diagonal / Up Right Diagonal

Up Left Diagonal / Down Right Diagonal

If the car does not move as per this sequence, you need check the wire connection.

Youtube Video Link: <https://www.youtube.com/embed/15qYSh9M5AE>

Lesson 2: Obstacle Avoidance Robot Car

OBJECTIVE

In this lesson, you must complete [lesson 1](#) before you continue on with this lesson. we use the ultrasonic module to “see” obstacle and measure the distance. If the distance is less than pre-defined threshold value, the car will turn around from the obstacle automatically.

PARTS & DEVICES

OSOY00 Mecanum Wheels Robotic Car Chassis x1(2xleft-wheels/2xright-wheels and Motor x 4)
OSOY00 Mega2560 board fully compatible with Arduino x 1
OSOY00 Wifi shield x 1
OSOY00 Model X motor driver x 2
OSOY00 SG90 servo motor x 1
OSOY00 Ultrasonic sensor module x1
OSOY00 Mount holder
OSOY00 Battery box x 1
18650 Batteries(3.7V) x 2

HARDWARE INSTALLATION

You must complete [lesson 1 \(assembling the car\)](#) before you continue on with this lesson. In this lesson3, we will add a servo motor and to the robotic car built in Lesson 1.

You must complete lesson 1 (assembling the car) before you continue on with this lesson. In this lesson2, we will add a servo motor and to the robotic car built in Lesson 1.

Step 1: Install Ultrasonic Module to mount holder with 4pcs M1.4*8 screw and M1.4 nuts.



Step 2: Remove screws on copper pillars and install servo motor at the front of upper car chassis with 2pcs M2.2*8 Self Tapping Screws.

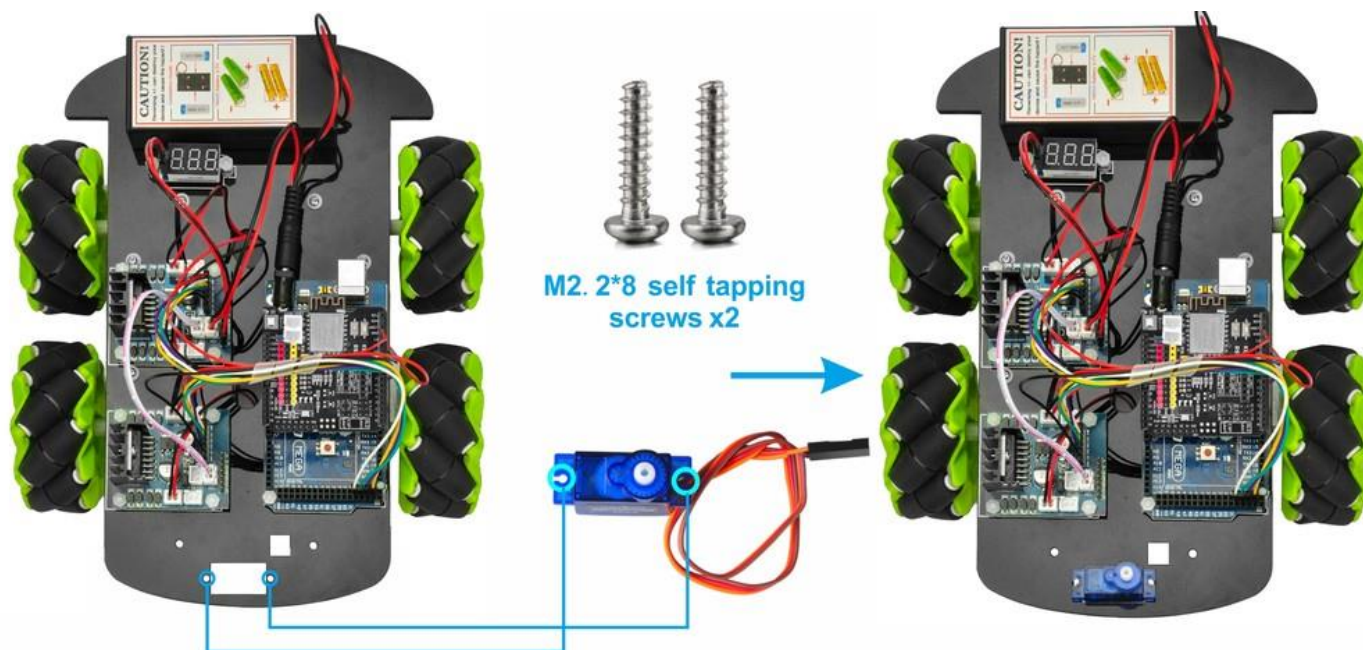

Step 3: Install mount holder for Ultrasonic Module on servo motor with M2*4 Self Tapping screw. (Please note: please upload code to adjust servo motor direction before fixing this screw)



CIRCUIT CONNECTION

If you just finishes Lesson 1, please keep all lesson 1 connections same as it is.

Step1: Connect Servo 3-pin head to any Model X board servo slot (yellow to S pin, red to 5v, brown to G pin), then connect another S pin to Wifi board D13.

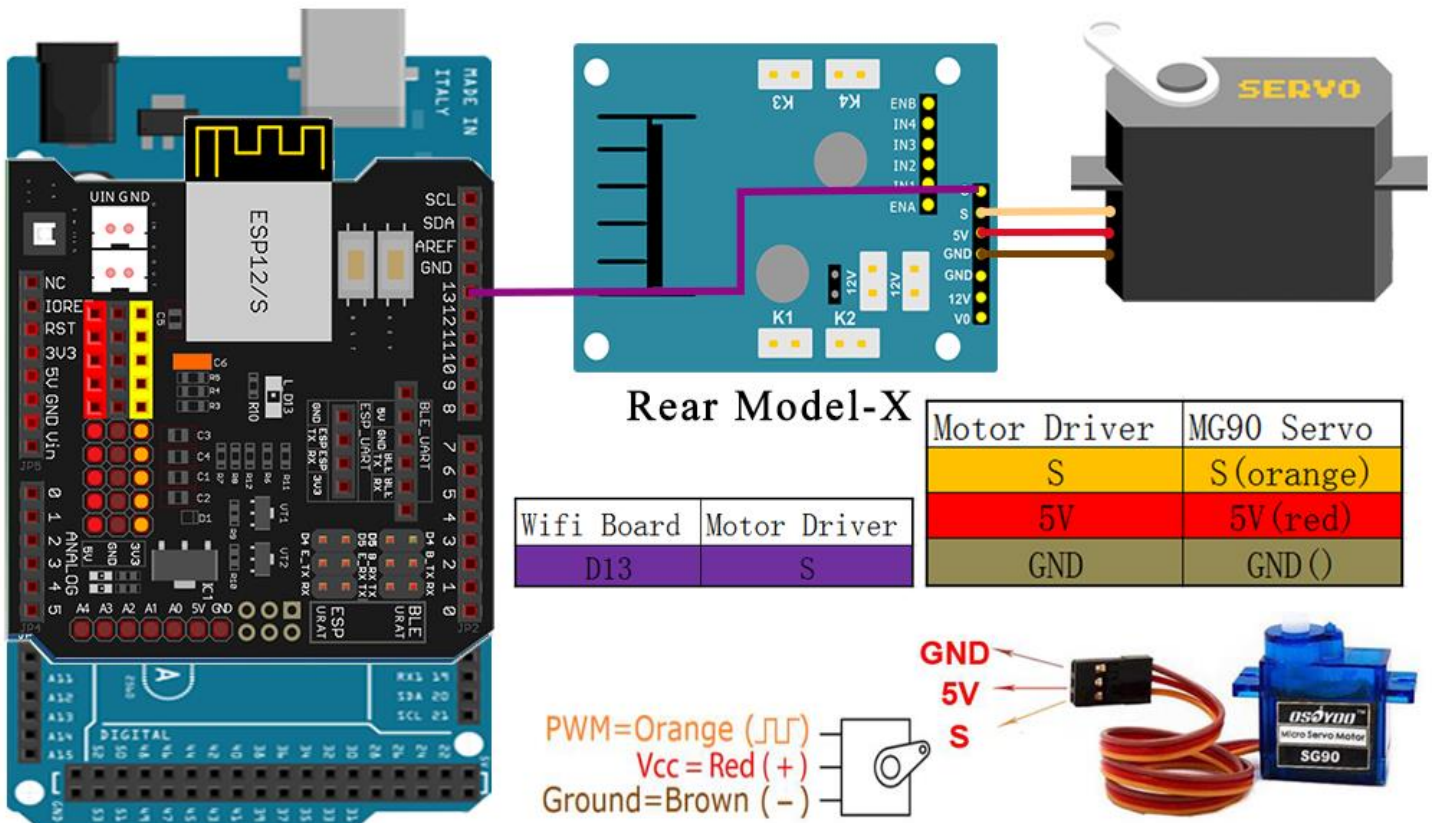

Step2: Connect Ultrasonic sensor module to Uart wifi board as following graph.

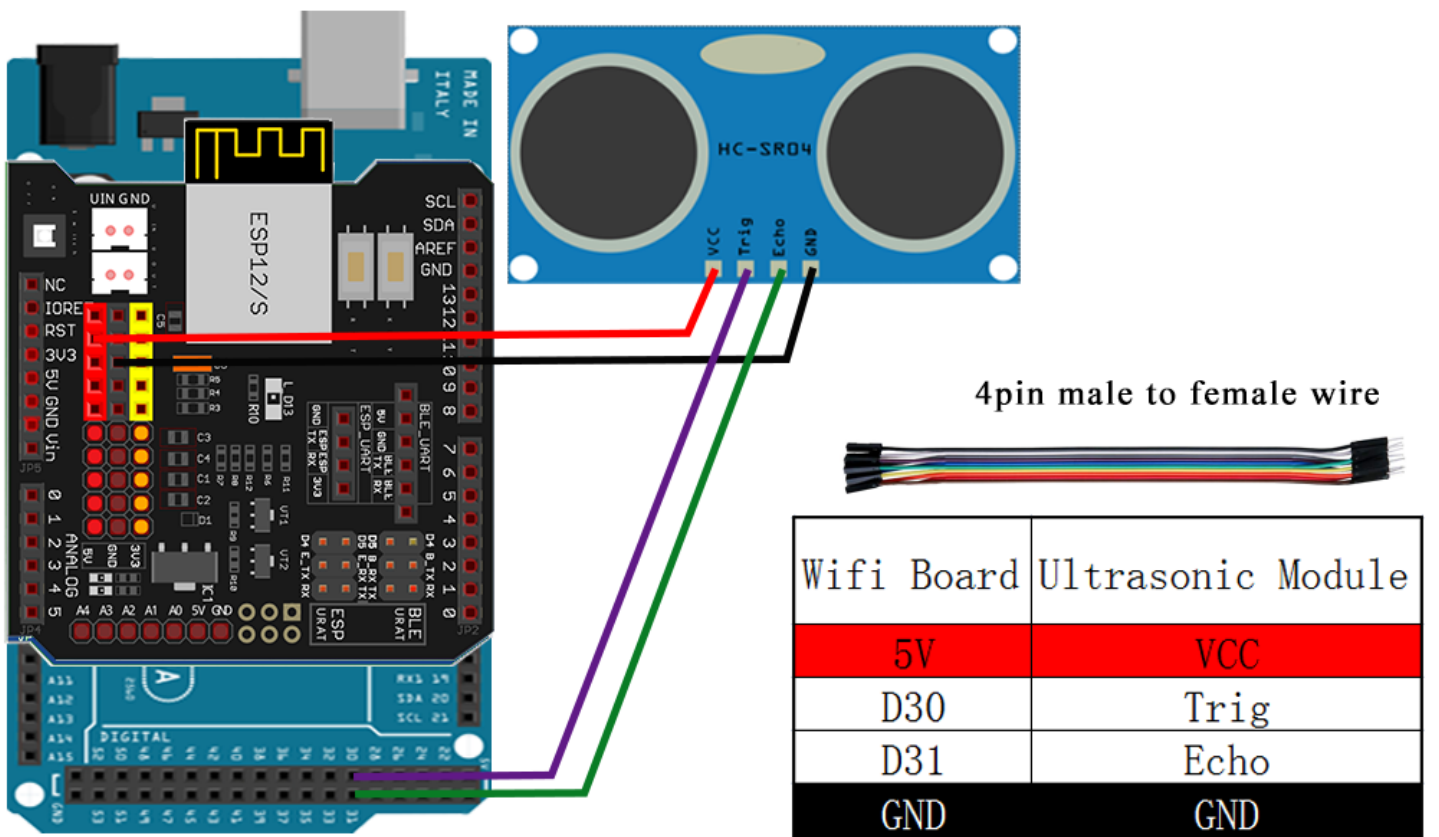

SOFTWARE INSTALLATION

Open-source Arduino Software(IDE)



Download Arduino IDE here:
<https://www.arduino.cc/en/Main/Software?setlang=en>

7 zip is a free zip utility that un-zips zip files



Download 7zip here for free
<https://www.7-zip.org/>

Step 1: Install latest Arduino IDE (If you have Arduino IDE version after 1.1.16, please skip this step). Download Arduino IDE from <https://www.arduino.cc/en/Main/Software?setlang=en> , then install the software.

Step 2: Download [https://osoyoo.com/driver/mecanum acrylic chassis/mecanum-2560-lesson2.zip](https://osoyoo.com/driver/mecanum%20acrylic%20chassis/mecanum-2560-lesson2.zip) , unzip the download zip file lesson2.zip, you will see a folder called lesson2 .

Step 3: Connect mega2560 board to PC with USB cable, Open Arduino IDE -> click file -> click Open -> choose code "lesson2.ino" in lesson folder, load the code into arduino as following:

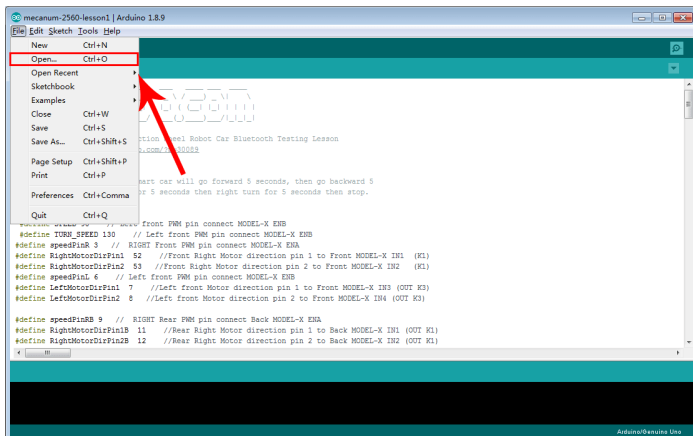

Step 4: Choose corresponding board/port for your project, upload the sketch to the board.

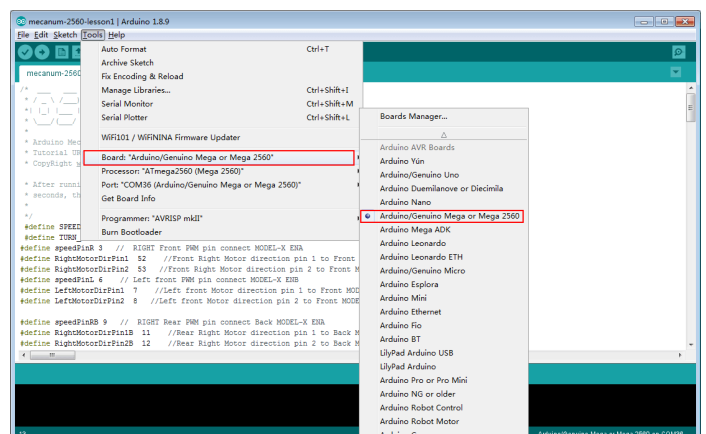
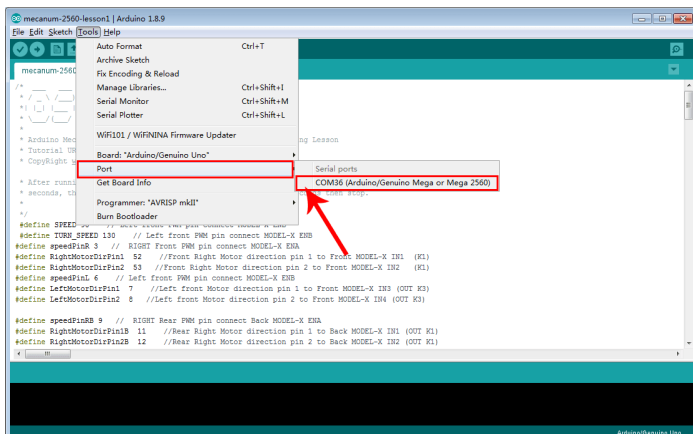

Step 5: Ultrasonic sensor servo initial direction alignment

After turning on the battery, the servo will make some movement and finally stops at a direction for 5 seconds. During this first 5 seconds, you must make sure the Ultrasonic sensor(two eyes) is facing straight forward.

If it is not straight forward, you should turn off battery immediately and remove the sensor from servo, reinstall it and make it facing straight forward direction as following picture.

Otherwise the obstacle avoidance program will not work properly. After adjusting sensor direction, turn on battery again. If its direction is not straight forward, turn off battery and do direction alignment again.

HOW TO PLAY

If the ultrasonic module turn to front view position, that means you no need adjust sensor position anymore. Just wait 5 seconds. If no obstacle is detected, the car will go forward. If any obstacles is detected, the car will stop, the ultrasonic module will turn from right to left to detect surrounding obstacle.

The robot car will decide to make left turn, right turn or backward according to obstacle sensor data and our obstacle avoidance algorithm. Sometimes your car might have collision and make your Ultrasonic sensor position change, you must remember to do sensor direction alignment again.

Youtube Video Link: <https://www.youtube.com/embed/5VRMH276oas>

Important parameters in the sketch file

Following parameters in Line 32 to 39 of mecanum-2560-lesson2.ino are very important to make performance tuning. See the comments in the #define statements:

```
#define FAST_SPEED 110 //The difference between FAST_SPEED and SPEED determines the
slight turning sharpness
#define SPEED 80 //forward moving speed
#define TURN_SPEED 110 //Turning Speed
#define FORWARD_TIME 200 //FORWARD_TIME determines Forward distance
#define BACK_TIME 300 // determines BACK MOVEMENT distance
#define TURN_TIME 250 //Determines turning sharpness
#define OBSTACLE_LIMIT 30 //minimum distance in cm to obstacles at both sides
```

Lesson 3: Tracking Line Robot Car

OBJECTIVE

In this lesson3, we will add a 3-Point tracking sensor module to the robotic car built in Lesson 1. The software in this lesson will read data from the 3-Point Tracking sensor module and automatically guide the smart car to move along the black track line in the white ground.

PARTS & DEVICES

OSOY00 Mecanum wheels robotic car chassis x1 (2xleft-wheels/2xright-wheels and Motor x 4)
OSOY00 Mega2560 board fully compatible with Arduino UNO/Mega2560 x1
OSOY00 Wifi shield x1
OSOY00 Model X motor driver x2
OSOY00 5-Point Tracking sensor module x1
OSOY00 7-pin female to female jumper wire x1
OSOY00 Battery box x1
18650 Batteries(3.7V) x2

HARDWARE INSTALLATION

You must complete [lesson 1 \(assembling the car\)](#), before you continue on with this lesson.

We will add a 5-Point tracking sensor module to the robotic car built in Lesson 3.



CIRCUIT CONNECTION

Start the installation from previous status of Lesson 1.

If you have installed Lesson 1, no need change anything, just keep the hardware wire connection as it is.

Connect VCC pin of tracking sensor module to 5V of Uart wifi shield;

Connect GND pin of tracking sensor module to GND of Uart wifi shield;

Connect IR1,IR2,IR3,IR4,IR5 pins to A0,A1,A2,A3,A4 with 7pin female to female cable as the following photo shows .

(Remember: DO NOT remove any existing wires installed in Lesson 1).

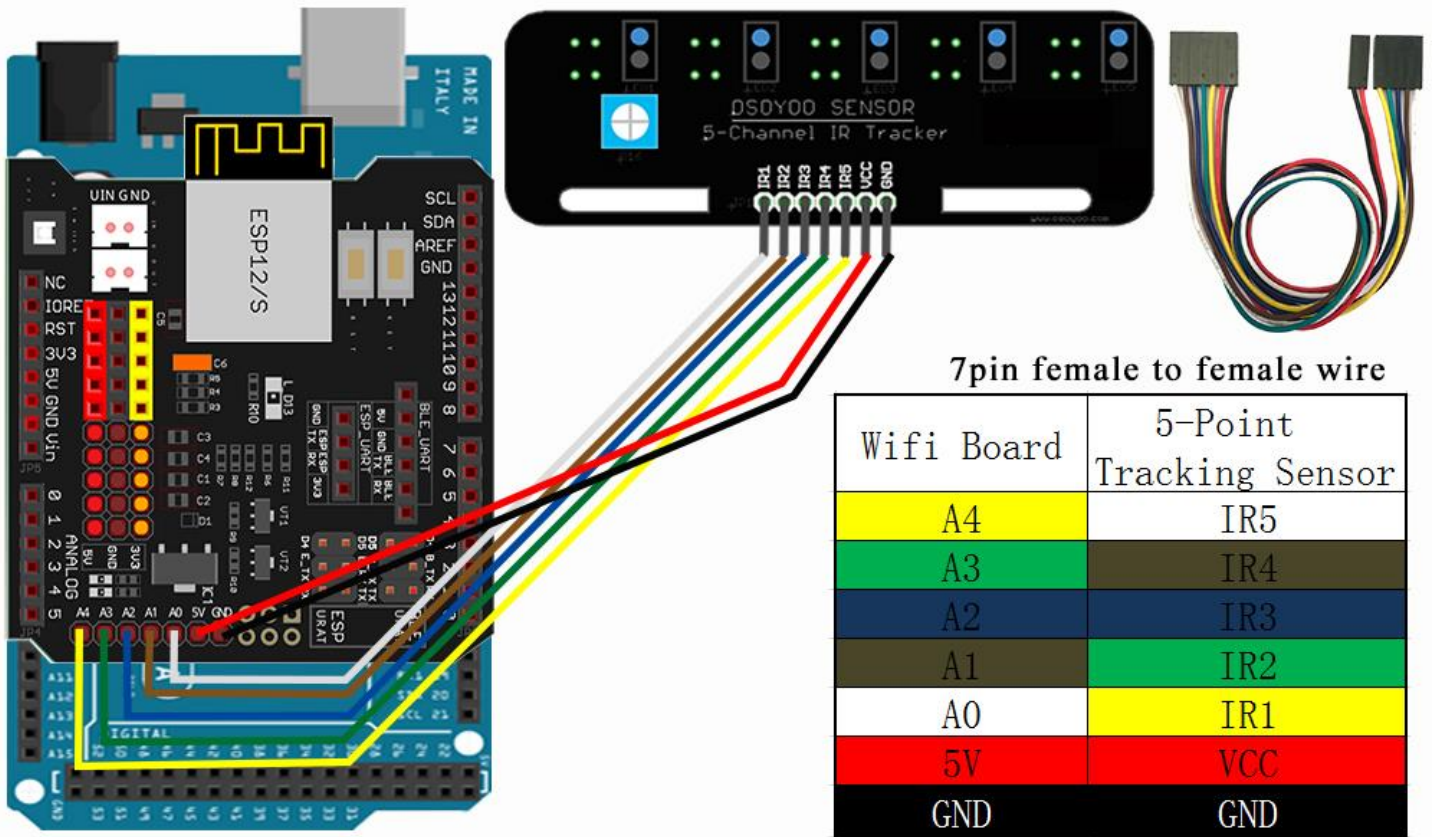

SOFTWARE INSTALLATION

Open-source Arduino Software(IDE)		Download Arduino IDE here: https://www.arduino.cc/en/Main/Software?setlang=en
7 zip is a free zip utility that un-zips zip files		Download 7zip here for free https://www.7-zip.org/

Step 1: Install latest Arduino IDE (If you have Arduino IDE version after 1.1.16, please skip this step). Download Arduino IDE from <https://www.arduino.cc/en/Main/Software?setlang=en> , then install the software.

Step 2: Download [https://osoyoo.com/driver/mecanum acrylic chassis/mecanum-2560-lesson3.zip](https://osoyoo.com/driver/mecanum%20acrylic%20chassis/mecanum-2560-lesson3.zip) , unzip the download zip file lesson3.zip, you will see a folder called lesson3 .

Step 3: Connect mega2560 board to PC with USB cable, Open Arduino IDE -> click file -> click Open -> choose code "lesson3.ino" in lesson folder, load the code into arduino as following:

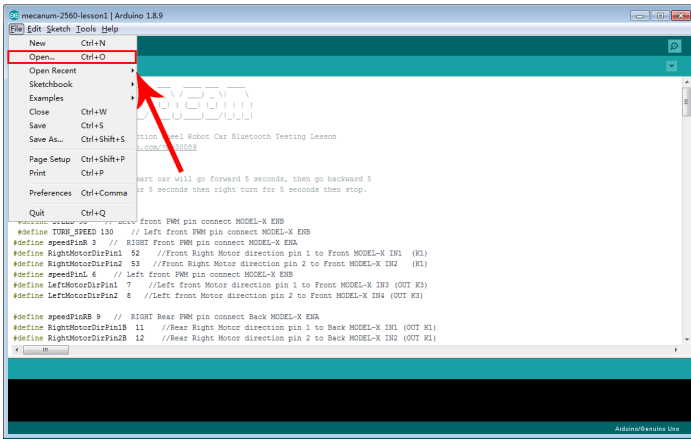

Step 4: Choose corresponding board/port for your project, upload the sketch to the board.

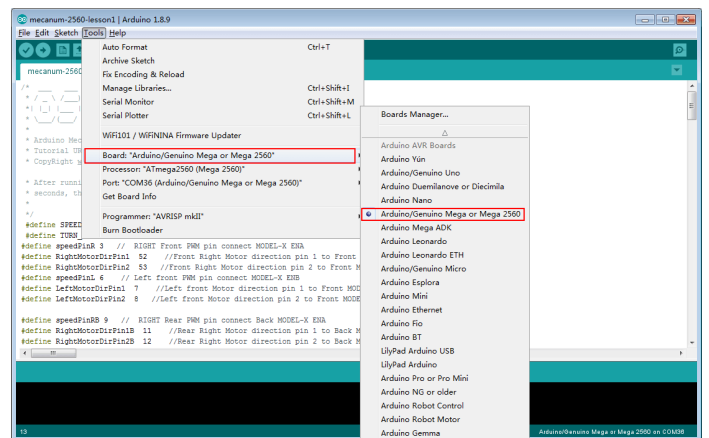
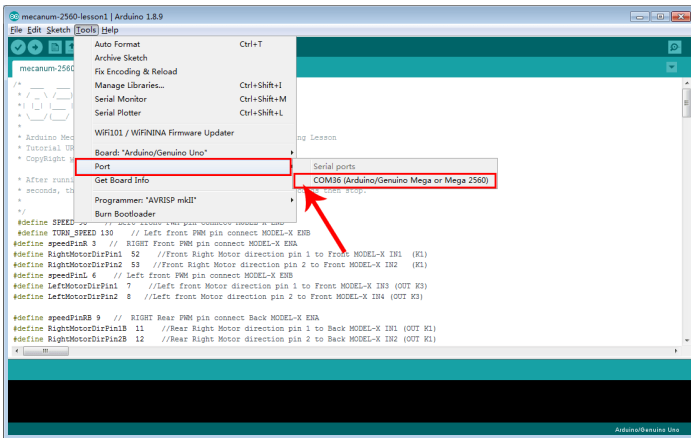

Step 5: Adjust the sensitivity of tracking sensor modules. Turn on and hold the car and adjust the potentiometer on the tracking sensor with cross screwdriver until you get the best sensitivity status: the signal indicate LED light will turn on when sensor is above white ground, and the signal LED will turn off when the sensor is above black track.

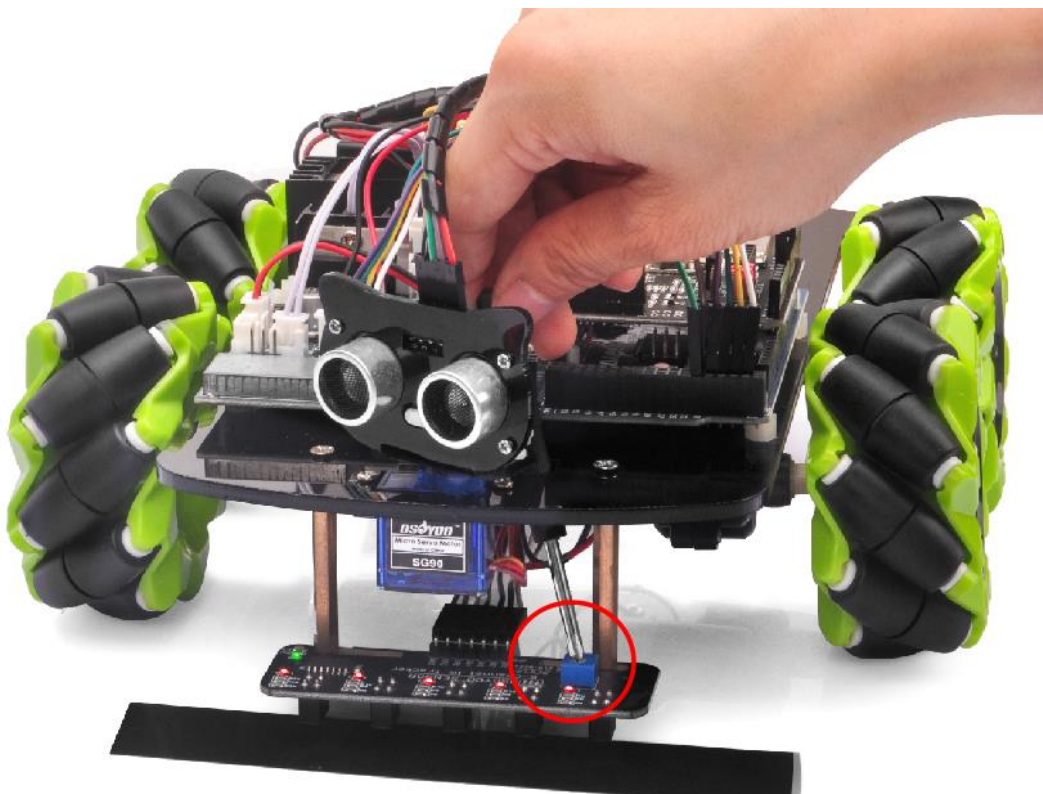

HOW TO PLAY

Prepare a black track (the width of the black track must be between 20mm and 30mm) in white ground. Please be noted that the bend angle of track can't be too sharp otherwise the car will move out of the track.

Turn on the car and put the middle of tracking sensor module facing over black track, and then the car will move along the black track automatically.

Youtube Video Link: lesson3- <https://www.youtube.com/embed/NTqsy7HC1Zc>

NOTICE

Motor Speed Tuning for better tracking performance

To get better tracking performance result, motor power(speed) value should be adjusted properly as per battery level. If motor power(speed) value is too high, your car might run too fast and easy to get out of track. If motor power(speed) is too low, the car might not even move.

To adjust the motor power value, you need change the 3 constants : MID_SPEED, HIGH_SPEED, LOW_SPEED in line 13, 14, 15 in mecanum-2560-lesson3.ino sketch file. Their default values are 70, 80, 60 which are good when batteries are fully charged.

After batteries are running low, you might need to increase the value of these 3 constants. You can gradually add or reduce 10 each time on these values and compare which values have best tracking performance.

Lesson 4: Bluetooth Imitation Robot Car

OBJECTIVE

In this lesson, we will use Mobile to control our robot car and make an imitation driving. Since is a mock driving, we will use a virtual steering wheel and gear in our APP to imitate their counterparts in real car.

In this lesson, Mecanum Omni wheel will allows robot car make omni-directional movement(parallel shift to left and right).

PARTS & DEVICES

OSOYOO Mecanum Wheels Robotic Car Chassis x1(2x left-wheels/2x right-wheels and 4x motor)

OSOYOO Mega2560 board fully compatible with Arduino

OSOYOO Uart Wifi Shield x 1

OSOYOO Model X motor driver x 2

OSOYOO HC02 bluetooth module

OSOYOO Battery box x 1

OSOYOO 10pin male to female jumper wire x1

18650 Batteries(3.7V) x2

HARDWARE INSTALLATION

You must complete [lesson 1 \(assembling the car\)](#) before you continue on with this lesson.No need change anything, just keep the hardware wire connection as it is.

STEP1: Connect B_TX and B_RX to D19 and D18.

(Note: You need split 2 pcs of male-to-female jumper wires from our 10-pc jumper wire bundle. Any color from the bundle will be ok. The rest of 8 pcs wires are as spare parts

for potential broken or damaged wires.)

Uart Wifi Board	Arduino mega2560
B_TX	D19
B_RX	D18

2pin male to female wire

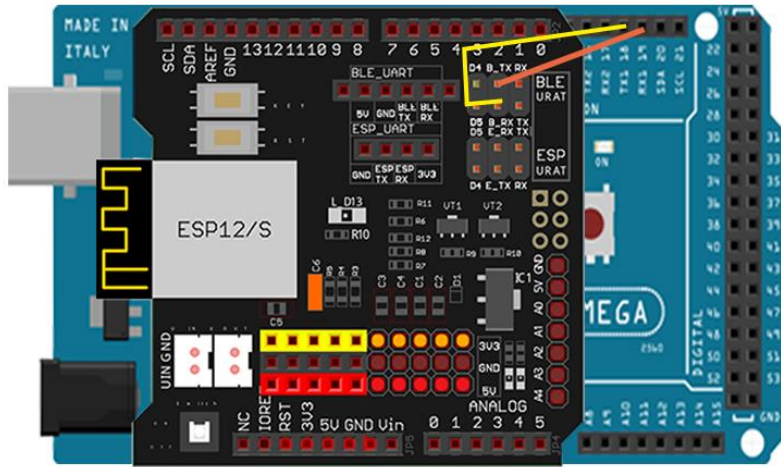

Step2: Bluetooth Module should be inserted into bluetooth 6-pin slot in OSOY00 Wifi Board

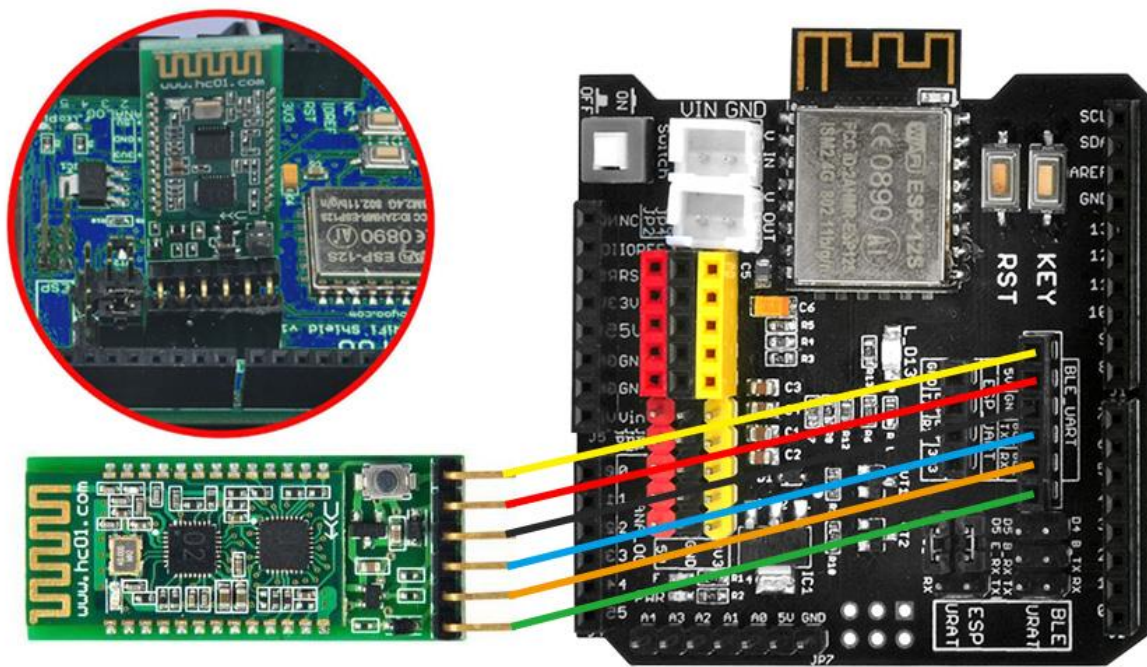

SOFTWARE INSTALLATION

Open-source Arduino Software(IDE)



Download Arduino IDE here:

<https://www.arduino.cc/en/Main/Software?setlang=en>

7 zip is a free zip utility that un-zips zip files



Download 7zip here for free
<https://www.7-zip.org/>

Step 1: Install latest Arduino IDE (If you have Arduino IDE version after 1.1.16, please skip this step). Download Arduino IDE from <https://www.arduino.cc/en/Main/Software?setlang=en> , then install the software.

Step 2: Download [https://osoyoo.com/driver/mecanum acrylic chassis/mecanum-2560-lesson4.zip](https://osoyoo.com/driver/mecanum%20acrylic%20chassis/mecanum-2560-lesson4.zip) , unzip the download zip file lesson4.zip, you will see a folder called lesson4 .

Step 3: Connect mega2560 board to PC with USB cable, Open Arduino IDE -> click file -> click Open -> choose code “lesson4.ino” in lesson4 folder, load the code into arduino.

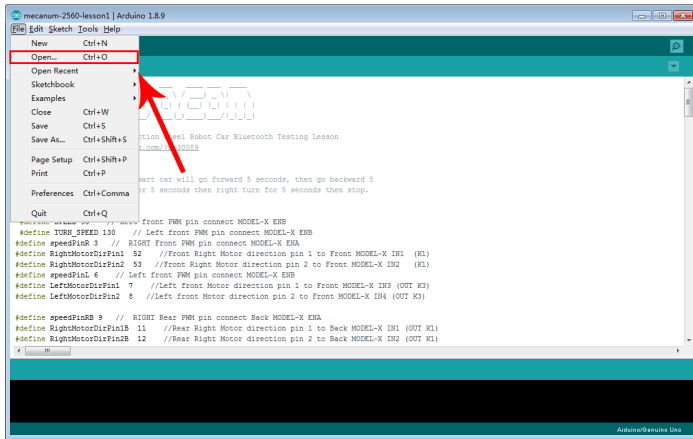

Step 4: Choose corresponding board/port for your project, upload the sketch to the board.

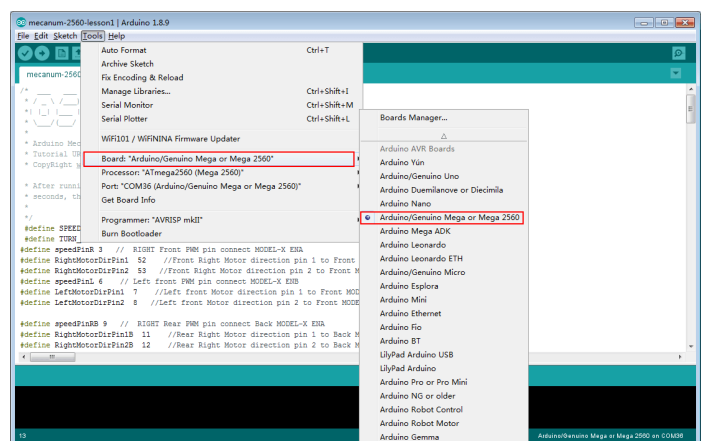
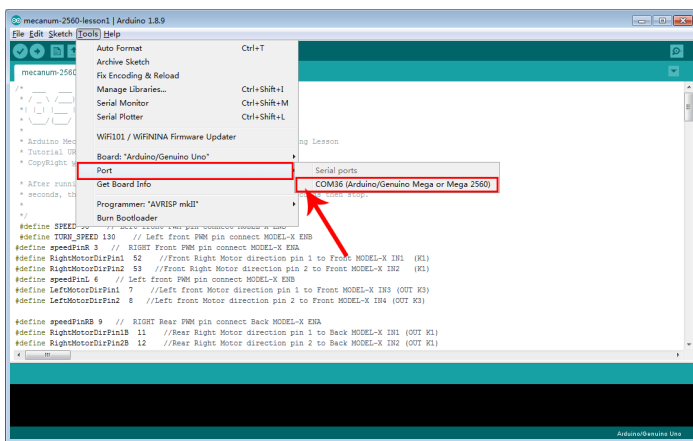

Mobile APP:

Go to your Google Play or Apple APP store and search APP name “OSOY00 imitation driving” , Download the APP as following and install it in your smart phone.

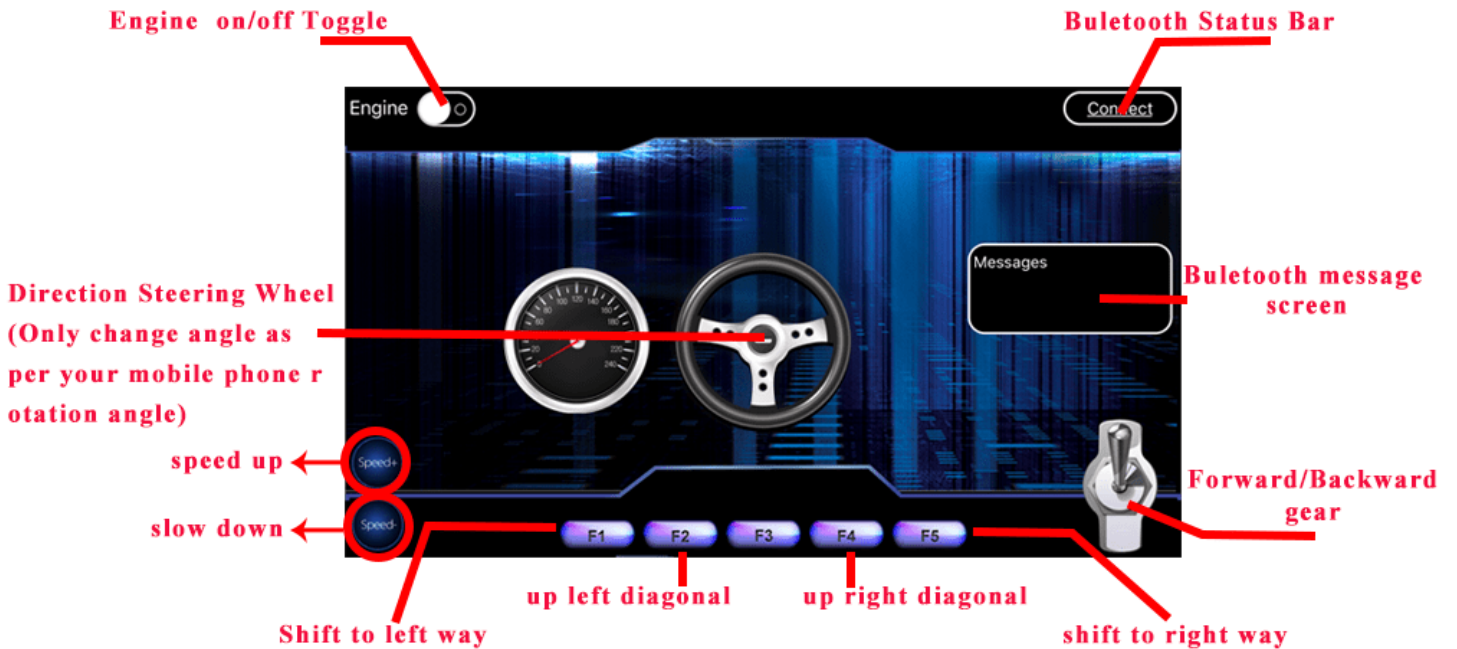
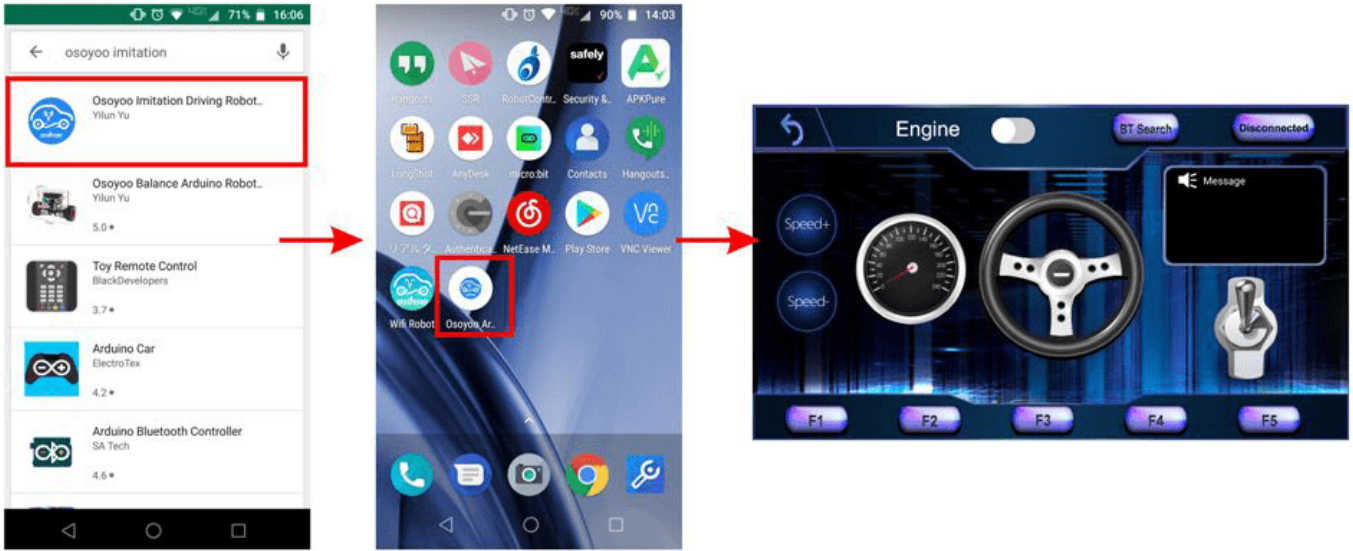

HOW TO PLAY

Power on the robot, and open APP.

- 1) If you have not paired Bluetooth module with your cell phone, please pair the bluetooth module first before open the APP. In your cell phone Setting->Bluetooth , find a Bluetooth device called **HC02**, pair it with password 1234
- 2) After bluetooth HC02 device is paired, open the APP. If you are using Android APP, Click **BT Search** Button to connect APP to HC02 device, if it is iOS APP, just click **connect**.
- 3) Click Engine Switch to start/stop the car

- 4) Click Speed +/- button to accelerate or reduce speed
- 5) Rotate the mobile phone to change direction(steering wheel will rotate while you are turning the phone).
- 6) Click Gear button to change gear to Forward or Backward direction.
- 7) Press F1 to Shift to left way, F5 to shift to right way, F3 to up left diagonal, F4 to up right diagonal.

Youtube Video Link: <https://youtu.be/GzVJng2rCBI>



Motor Speed Tuning for better performance

To get better running performance result, motor power(speed) value should be adjusted properly as per battery level. If motor power(speed) value is too high, your car might run too fast and easy to out of control. If motor power(speed) is too low, the car might not even move.

To adjust the motor power value, you need change the 3 constants line 27,28,29 in mecanum-2560-lesson4.ino sketch file:

```
#define MIN_SPEED 50  
#define TURN_SPEED 70  
#define SLOW_TURN_SPEED 50  
#define BACK_SPEED 60
```

MIN_SPEED is the minimum power required to start the car. If when APP engine toggle is switched to RED, but your car does not move, you need increase this value , if the car runs too fast at engine start moment, you need reduce this value.

TURN_SPEED AND, SLOW_TURN_SPEED value determines the turning speed of your car. If your car turning too fast, you need reduce these two values, if turning too slow or not turning, increase these two values. Always make SLOW_TURN_SPEED about 20 to 30 lower than TURN_SPEED value.

BACK_SPEED value determines the reverse back running speed.

After batteries are running low, you might need to increase the value of these 3 constants. You can gradually add or reduce 10 each time on these values and compare which values have best tracking performance.

Lesson 5: Wifi IoT Control Robot Car

OBJECTIVE

In this project we will connect Robot Car to Wifi and Use an APP to control the car through Internet. This is a typical Internet of Things(IoT) Application.

PARTS & DEVICES

OSOY00 Mecanum Wheels Robotic Car Chassis x1(2x left-wheels/2x right-wheels and 4x motor)
OSOY00 Mega2560 board fully compatible with Arduino
OSOY00 Uart Wifi Shield x 1
OSOY00 Model X motor driver x 2
OSOY00 Battery box x 1
18650 Batteries(3.7V) x 2

HARDWARE INSTALLATION

If you just finishes all [Lesson 1](#) - [Lesson3](#) please keep all lesson connections same as it is. Then plug out bluetooth from Wifi Shield.

CIRCUIT CONNECTION

Remove the connection B_TX and B_RX to D18 and D19.

Connect E_TX to D19(RX1) and E_RX to D18(TX1)

(Note: You need split 2 pcs of male-to-female jumper wires from our 10-pc jumper wire bundle. Any color from the bundle will be ok. The rest of 8 pcs wires are as spare parts for potential broken or damaged wires.)

Wifi Board	Arduino mega2560
E_TX	D19
E_RX	D18

2pin male to female wire

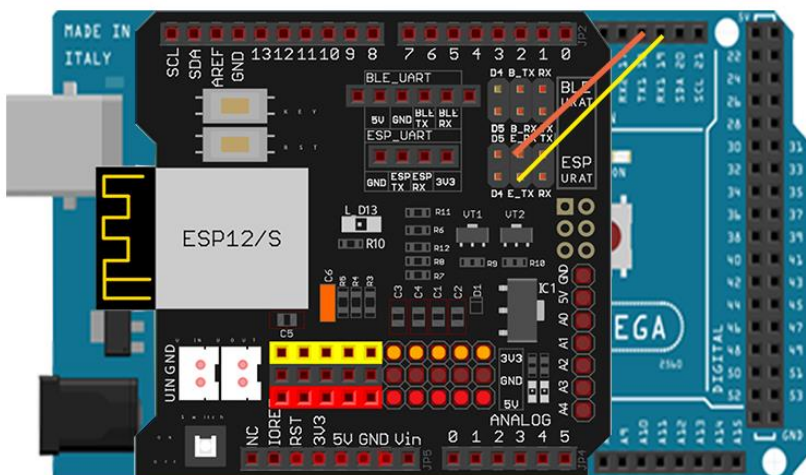

SOFTWARE INSTALLATION

Open-source Arduino Software(IDE)		Download Arduino IDE here: https://www.arduino.cc/en/Main/Software?setlang=en
7 zip is a free zip utility that un-zips zip files		Download 7zip here for free https://www.7-zip.org/

Step 1: Install latest Arduino IDE (If you have Arduino IDE version after 1.1.16, please skip this step). Download Arduino IDE from <https://www.arduino.cc/en/Main/Software?setlang=en> , then install the software.

STEP2: Please download the library zip file from [WiFiEsp-master](#) .Open Arduino IDE ->click Sketch ->Include Library ->Add .ZIP library , then load above zip file into Arduino.

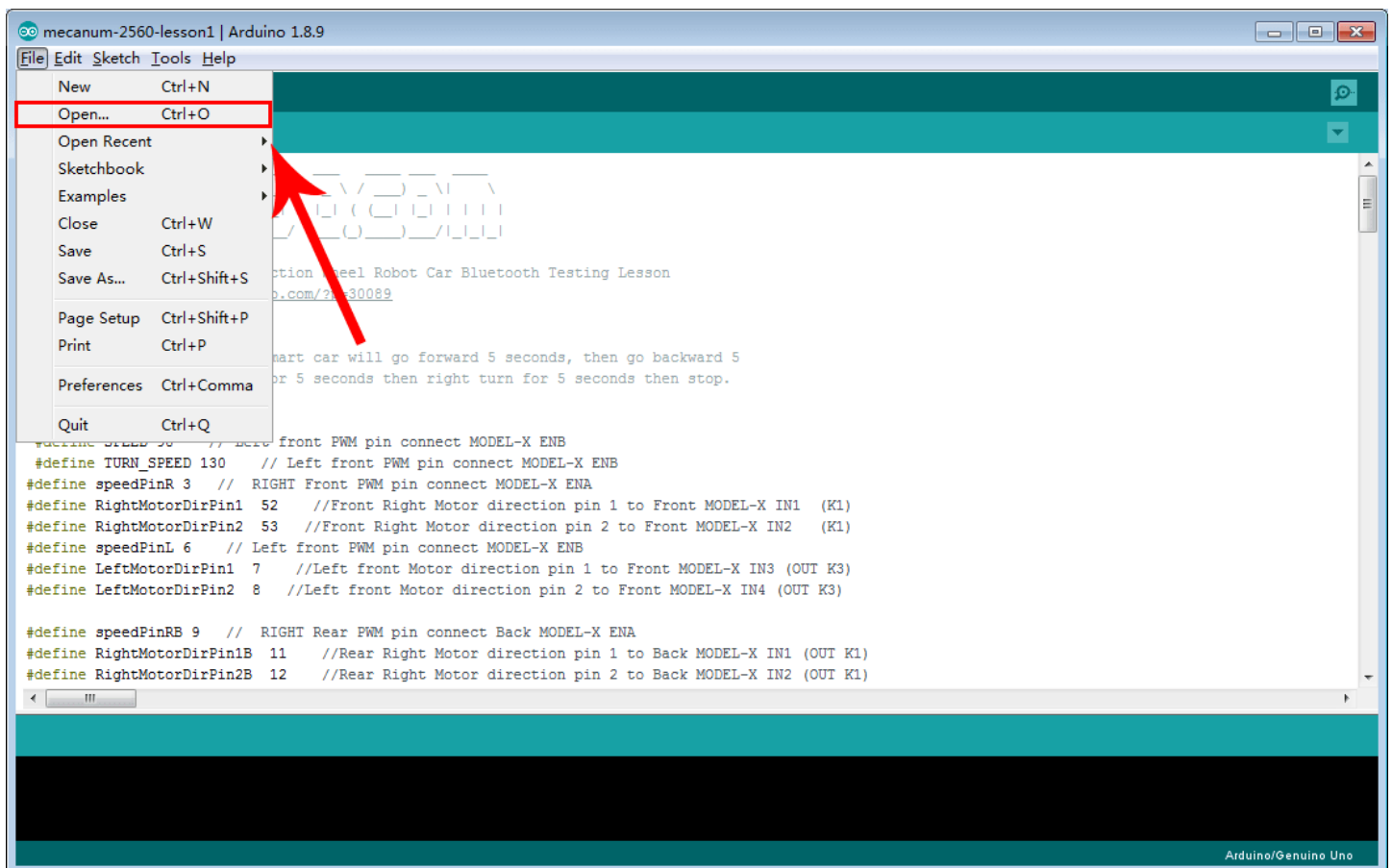

STEP3: Search Google Play or Apple Store with the Keywords “OSOY00 Wifi UDP Robot Car Controller ” and Download the APP.

DOWNLOAD APP FROM <https://osoyoo.com/driver/arduino-udp/udp-robot.apk>

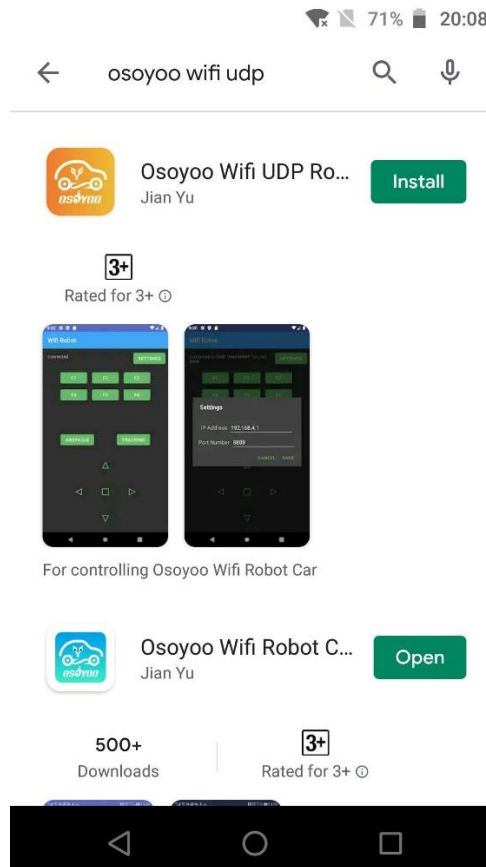
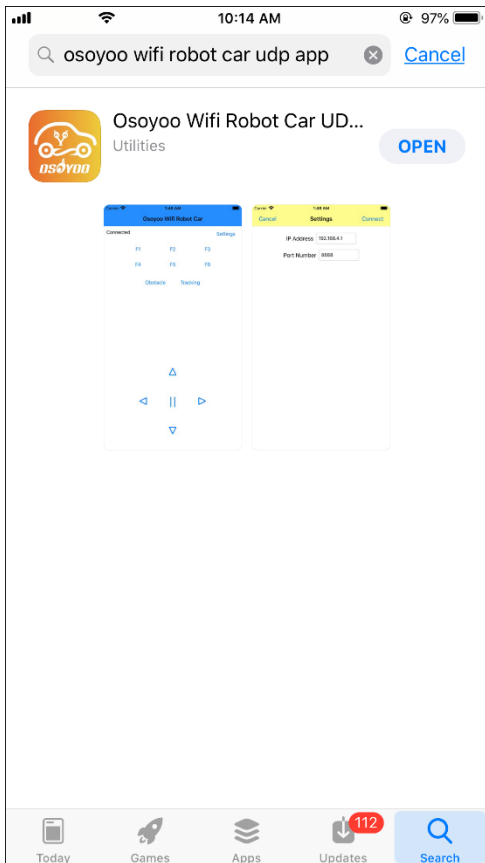

STEP4: Arduino Sketch code Installation:

Robot Car can work in two Wifi modes: AP mode and STA mode. The Arduino sketches for these two modes are different. Let's explain these two modes one by one.

--- *AP MODE* ---

When working in AP mode, our robot car itself will become a Wifi Hot Spot. Our cell phone can connect to Robot Car as its wifi client. The IP address of Robot is fixed as 192.168.4.1 and It is not connected to WAN.

(1) Please download sketch from following link:

https://osoyoo.com/driver/mecanum_acrylic_chassis/mecanum-2560-lesson5A.zip. Unzip the file and you will see a folder named mecanum-2560-lesson5A, upload the code into Arduino

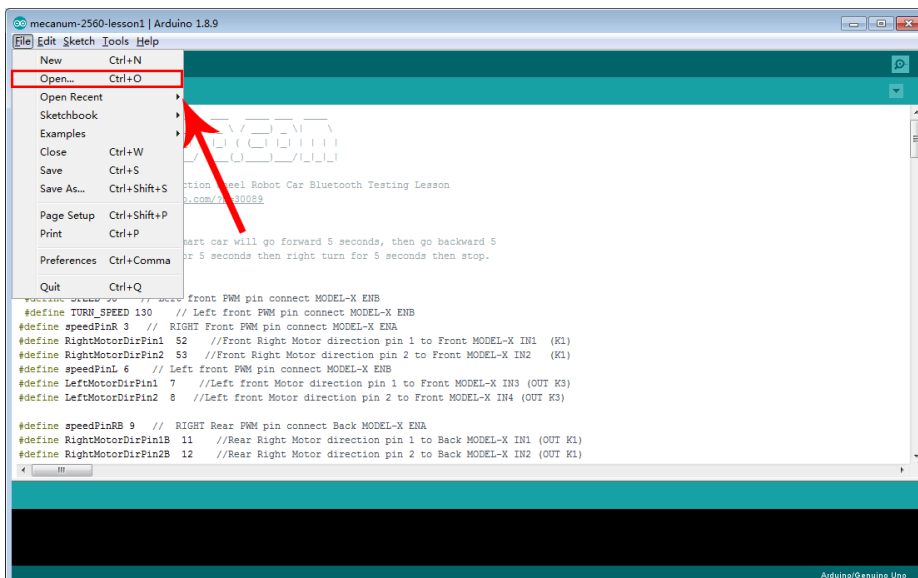

(2) Open your Arduino Serial monitor, and you will see a similar result as AP mode. A new Wifi SSID “osoyoo_robot” with IP address 192.168.4.1 will show up in the window. This means your Robot car has a Wifi Hot Spot name “osoyoo_robot” , its IP address is 192.168.4.1

(3) Open your Arduino Serial monitor and set 9600 baud, then you will see a similar result as AP mode. A new Wifi SSID “osoyoo_robot” with IP address 192.168.4.1 will show up in the window. This means your Robot car has a Wifi Hot Spot name “osoyoo_robot” , its IP address is 192.168.4.1, port No. 8888 .



(4) Connect your cell phone to “osoyoo_robot” wifi hot_spot, you can use Mobile phone control the robot car.



(5) You can click the “<” “>” “^” “v” direction keys to make the car move. Use “|” pause key to stop the car movement.

Click Obstacle to shift left side, Click Tracking to shift right side.

Click F1 to make upper-left diagonal movement, Click F3 to make upper-right diagonal movement

Click F4 to make back-left diagonal movement, Click F6 to make back-right diagonal movement.



In STA mode, robot car does not work as a wifi hotspot. Instead, it will become an internet node in your LAN. You need tell Arduino sketch what is your local router's Wifi SSID and password, then Arduino talks to router and get its own LAN IP address from DHCP server. You can use Mobile APP to access the robot car's IP address and control its movement.

(1) Please download STA mode sketch code from

[https://osoyoo.com/driver/mecanum acrylic chassis/mecanum-2560-lesson5B.zip](https://osoyoo.com/driver/mecanum%20acrylic%20chassis/mecanum-2560-lesson5B.zip) . Unzip the file and you will see a folder named mecanum-2560-lesson5b, then load themecanum-2560-lesson5b.ino code into Arduino

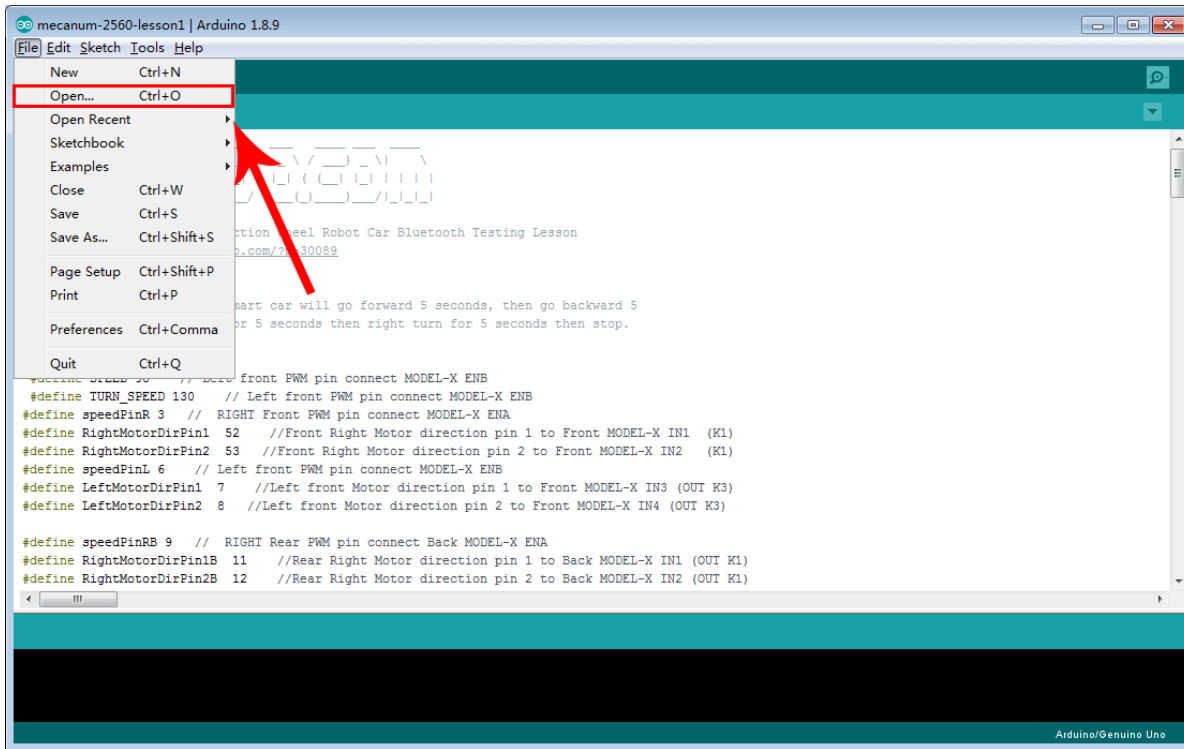

(2) You need change the code Line 176 and Line 177 :

```
char ssid[] = "YOUR_ROUTER_SSID"; // replace this with your router wifi SSID
char pass[] = "YOUR_ROUTER_WIFI_PASSWORD"; // replace with your wifi password
```

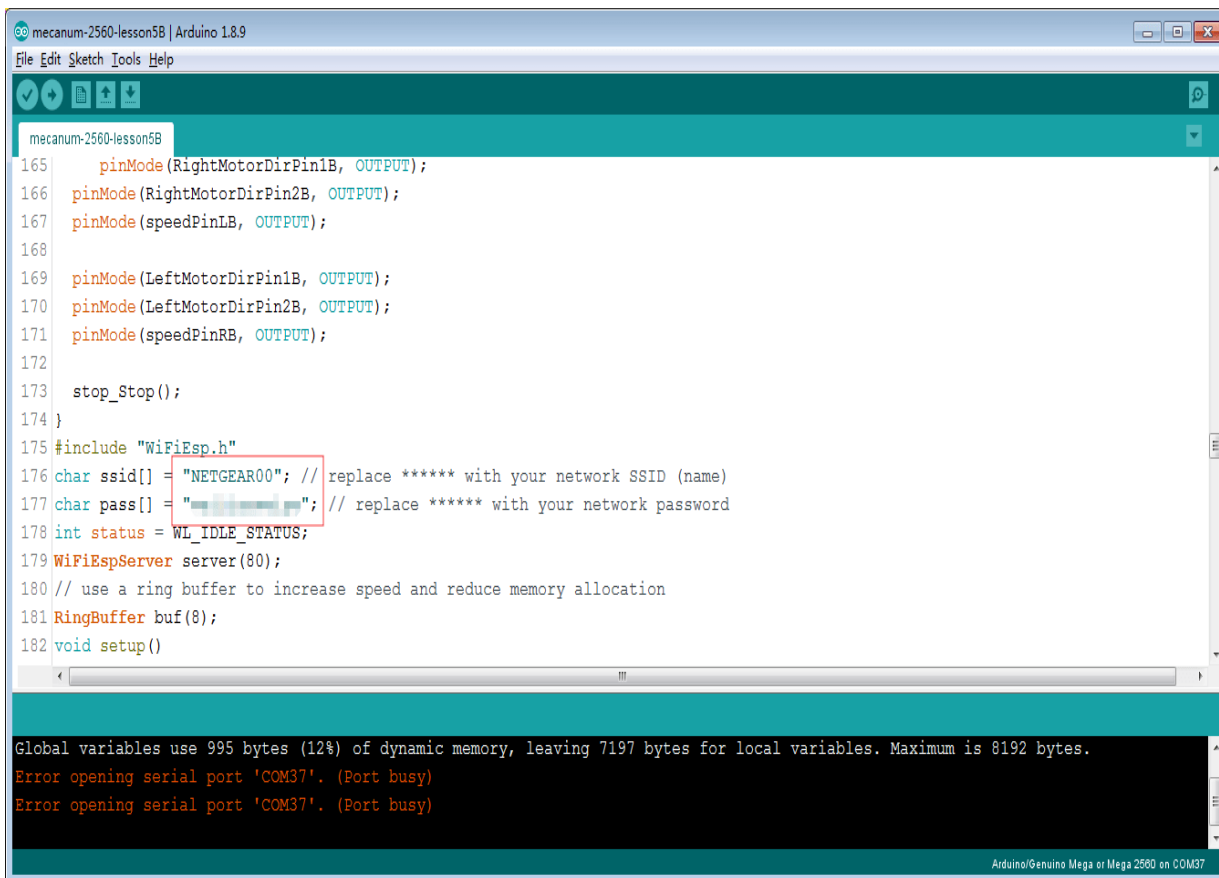

(3) Upload the sketch to Arduino. Finally, click the Serial monitor window in upper right corner of Arduino IDE and set 9600 baud, then you will see following result:

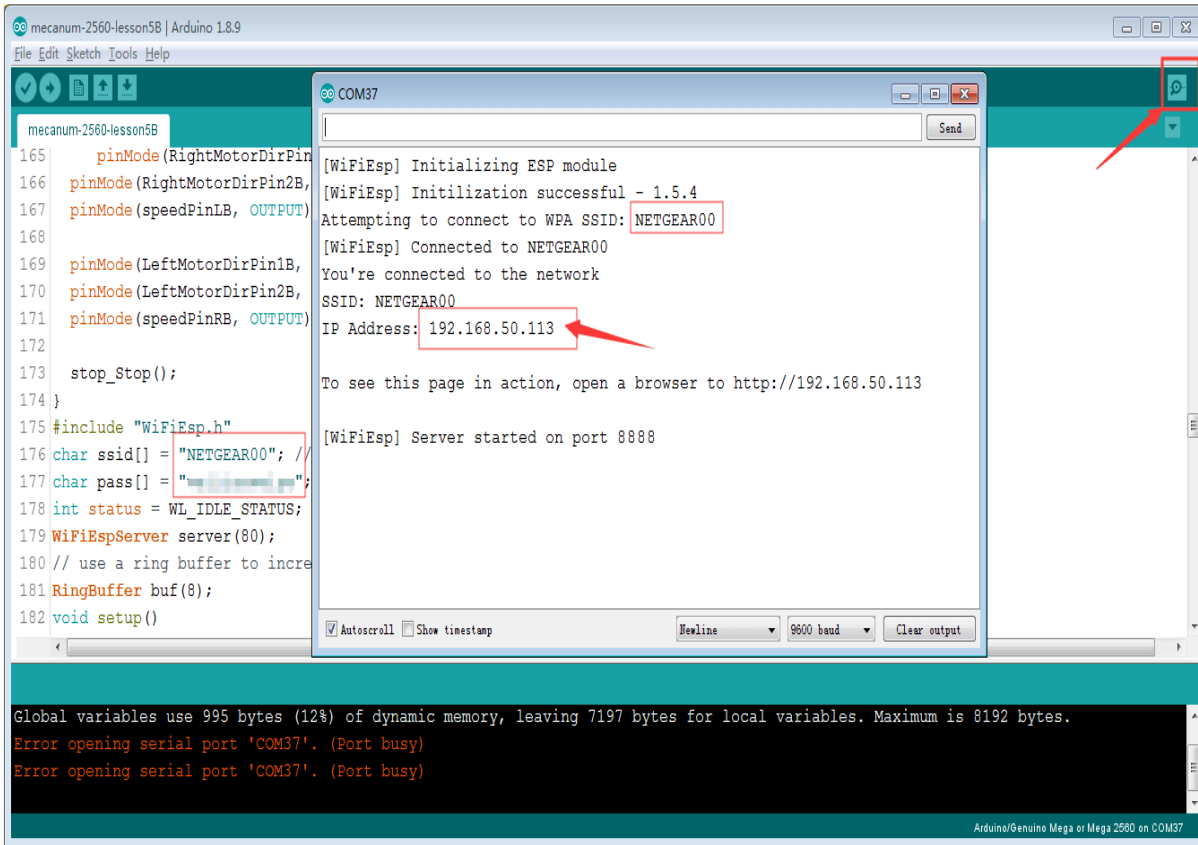

(4) In this mode, you will see an IP address which is our LAN IP address assigned by my router. Please write down this IP address and click Setting to set up robot IP address and set this IP address to your APP Setting section (no need change default port 8888 in APP).

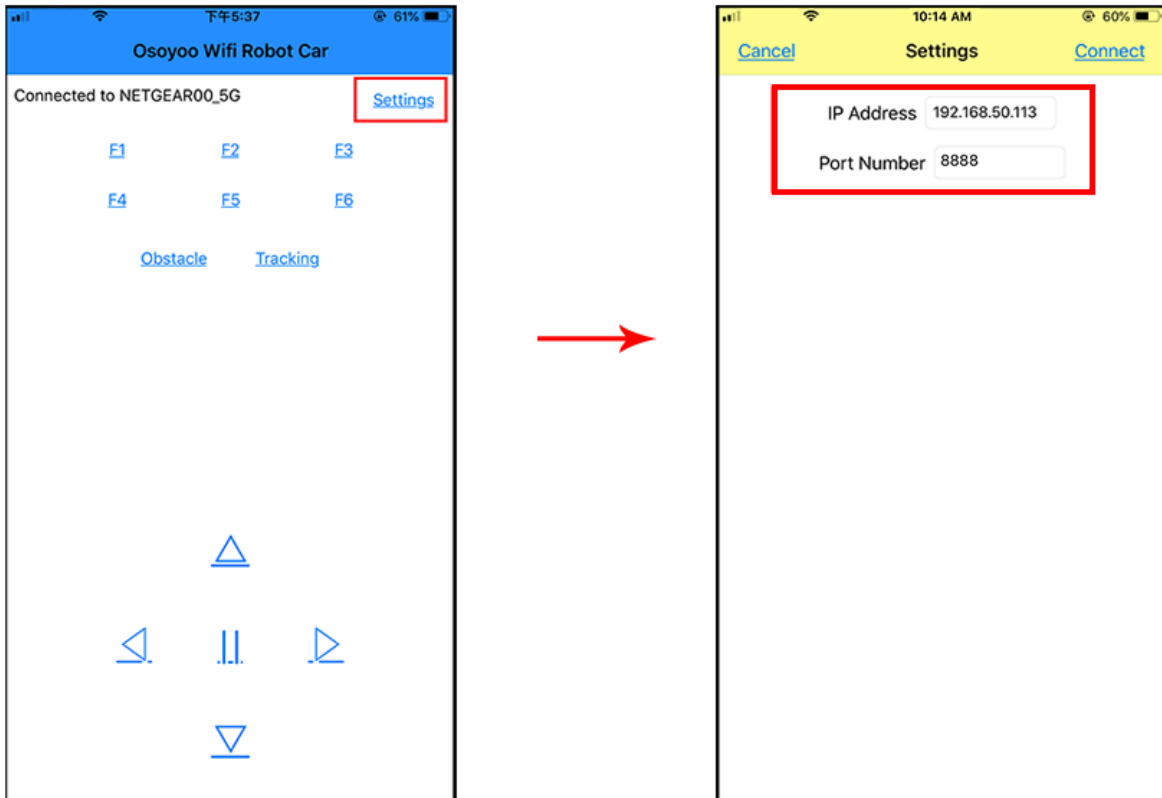

(5) Now your Robot car is connected to your LAN, you can use Mobile phone under same LAN to control the robot car. If your APP is in WAN, you need to go to your Router Control

Panel, forward Port 80 to Robot car LAN IP address, then you can use Router IP to control the car. This feature makes our robot car A REAL INTERNET OF THING device

(6) You can click the “<” “>” “^” “v” direction keys to make the car move. Use “||” pause key to stop the car movement.

Click Obstacle to shift left side, Click Tracking to shift right side.

Click F1 to make upper-left diagonal movement, Click F3 to make upper-right diagonal movement

Click F4 to make back-left diagonal movement, Click F6 to make back-right diagonal movement.



Speed tuning

If you want change the speed performance of the robot car, please following parameters in line 11 to 13:

```
#define SPEED 85
#define TURN_SPEED 90
#define SHIFT_SPEED 130
```

SPEED value determines forward moving speed

TURN_SPEED value determines turning speed

SHIFT_SPEED value determines parallel shifting speed

